



MOTORTRONICS™

Solid State AC Motor Control

MVC₄ Series

MEDIUM VOLTAGE SOLID STATE SOFT STARTER



USER MANUAL
10 - 13.8 kV



ABS

Table of Contents

	PAGE
Chapter 1: Introduction	1
1.1 Overview.....	1
1.2 Specifications.....	1-2
1.3 Reference Chart	3
1.4 Design Features	4
1.5 Theory of Operation	4-5
1.6 General Protection	5-6
1.7 Thermal Overload Protection	6
1.8 Firing Circuit.....	7
1.9 Electronics	8
Fig. 1.9 Keypad Interface	8
Chapter 2: Connections	10
2.1 Warnings	10
2.2 Control Connections	11
2.2.1 TCB Board	10
Fig. 2.2.1 TCB Terminal and Control Board	10
2.2.2 Description of Terminal Connections.....	12-14
2.2.3 Description of Jumper Selections and Functions.....	15
2.2.4 Description of Switch Settings and Functions.....	15
2.2.5 Description of LED Indicator Functions	16
2.3 Circuit Board Layout Reference Section	17-19
Fig. 2.3.1 Optional RTD Board	17
Fig. 2.3.2 RS485 / RS422 Communications Board.....	17
Fig. 2.3.3 Main Board.....	18
Fig. 2.3.4 CPU Board.....	19
2.4 Typical Wiring Diagram.....	20
Fig. 2.4 Typical Wiring Diagram	20
Chapter 3: Start-Up	21
3.1 Introduction.....	21
3.2 Acceleration Adjustments.....	21
3.3 Deceleration Adjustments	22
3.4 Sequence of Normal Operation.....	23
3.5 Emergency Bypass Operation.....	25
Chapter 4: User Interface and Menu Navigation	26
4.1 Keypad/Operator Interface.....	26
4.1.1 Keypad Operator designations and functions	26
4.2 Menu Navigation	27
4.2.1 Password Access.....	28
4.2.2 Changing Setpoints.....	28
Chapter 5: Setpoint Programming	29
5.1 Setpoints Page List.....	29-35
5.1.1 Basic Configuration (Setpoint Page 1)	29
5.1.2 Starter Configuration (Setpoint Page 2)	29
5.1.3 Phase and Ground Settings (Setpoint Page 3)	30
5.1.4 Relay Assignments (Setpoint Page 4)	31

5.1.5 Relay Configuration (Setpoint Page 5)	32
5.1.6 User I/O Configuration (Setpoint Page 6)	32
5.1.7 Custom Acceleration Curve (Setpoint Page 7)	33
5.1.8 Overload Curve Configuration (Setpoint Page 8)	33
5.1.9 RTD Option Configuration (Setpoint Page 9)	34
5.1.10 RTD Password Level Configuration (Setpoint Page 10)	35
5.1.11 Communication (Setpoint Page 11)	35
5.1.12 System (Setpoint Page 12)	35
5.1.13 Calibration and Service (Setpoint Page 13)	35
5.2 Setpoints Menu and Parameter Explanation	36-65
SP.1 Basic Configuration	36
SP.2 Starter Configuration	37-42
Fig. SP2.3 Example of Switching from Jog to Start Ramp #1 Type: Voltage	39
Fig. SP2.4 Power Ramp.....	41
SP.3 Phase & Ground Settings.....	43-46
Fig. SP3.5 Overcurrent Trip Delay Graph.....	43
SP.4 Relay Assignment	47-42
SP.5 Relay Configuration.....	48
SP.6 User I/O Configuration.....	49-51
SP.7 Custom Acceleration Curve.....	52-54
SP.8 Overload Curve Configuration	55-56
SP.9 RTD Option Configuration	57-59
SP.10 Set Password.....	60
SP.11 Communications	60
SP.12 System Setpoints	61-62
SP.13 Calibration & Service.....	63
Chapter 6: Metering Pages	64
6.1 Metering Page List.....	64
6.1.1 Metering Menu & Data (Metering Page 1)	64
6.1.2 Metering (Metering Page 2)	64
6.1.3 RTD Option Values (Metering Page 3)	64
6.1.4 Status (Metering Page 4)	64
6.1.5 Event Recorder (Metering Page 5)	65
6.1.6 Last Trip (Metering Page 6)	65
6.1.7 Statistics (Metering Page 7)	65
6.2 Metering Menu and Explanation.....	66
MP.1 Metering Data.....	67
MP.2 Metering	68
MP.3 RTD Values	69
MP.4 Status	70
MP.5 Event Recorder – 60 Events.....	71
MP.6 Last Trip	72
MP.7 Statistics.....	73
Chapter 7: Maintenance and Troubleshooting	74
7.1 Failure Analysis	74-76
7.1.1 SCR Testing Procedure	77
APPENDIX A: Modbus RTU Communication and MVC Plus Registers	78

Chapter 1 - Introduction

This chapter is an introduction to the Reduced Voltage Solid State Soft Starter for medium voltage AC motors. It is highly recommended that users read this section thoroughly to become familiar with the basic configuration, operation and features before applying the Soft Starter.

1.1 Overview

The standard Soft Starter is an SCR-based controller designed for the starting, protection and control of AC medium voltage motors. It contains SCR stack assemblies, fiber optic connections, and low voltage control circuitry ready to be interfaced with an enclosure and the necessary equipment to create a complete a Class E2 medium voltage motor Soft Starter.

1.2 Specifications

GENERAL	
AC Supply Voltage	10000 – 13800 VAC +10 to – 15% (Model dependent)
Unit Running Overload Capacity (Percent of motor FLA)	125% - Continuous 500% - 60 seconds, 600% - 30 seconds. 1 Cycle: Up to 14x FLA (Internally protected by the programmable short circuit)
Frequency	50 or 60Hz, +2Hz hardware selectable
Power Circuit	36 SCRs
SCR Peak Inverse Voltage Ratings	27000V - 39000V (Model dependent see Table 1) Note: Contact Factory
Phase Insensitivity	User selectable phase sequence detection
Transient Voltage Protection	RC snubber dv/dt networks (One per inverse pair of SCRs)
Ambient Condition Design	Enclosed units: 0° to 40°C (32° to 104°F) (optional - 20° to 50° C with heaters) 5 - 95% relative humidity 0 - 3300 ft. (1000m) above sea level without de-rating (Ratings for ambient conditions external to unit)
Control	2 or 3 wire 120VAC (Customer supplied)
Auxiliary Contacts	Multiple: Form C (Contacts), rated 5 Amps, 240VAC max.
	8 Relays (4 programmable): Form C contacts
	Fault Indicator: Form C contacts
BIL Rating	110kV
Approvals	UL recognized, Canadian UL (cUL) recognized

ADVANCED MOTOR PROTECTION	
Two Stage Electronic Overload Curves	Starting: Programmable for Class 5 through 30 Run: Programmable for Class 5 through 30 when "At-Speed" is detected.
Overload Reset	Manual
Retentive Thermal Memory	Overload circuit retains thermal condition of the motor regardless of control power status. Unit uses real time clock to adjust for off time.
Dynamic Reset Capacity	Overload will not reset until thermal capacity available in the motor is sufficient for a successful restart. Starter learns and retains this information by monitoring previous successful starts.
Phase Current Imbalance Protection	Imbalance Trip Level: 5 - 30% current between any two phases Imbalance Trip Delay: 1 -20 seconds
Over Current Protection (Electronic Shear Pin)	Trip Level: 100 - 300% of motor FLA Trip Delay: 1 - 20 seconds
Load Loss Trip Protection	Under Current Trip Level: 10 -90 % of motor FLA Under Current Trip Delay: 1 - 60 seconds
Coast Down (Back Spin) Lockout Timer	Coast Down Time Range: 1 - 60 minutes
Starts-per-hour Lockout Timer	Range: 1 - 6 successful starts per hour Time between starts: 1 - 60 minutes between start attempts

PROGRAMMABLE OUTPUTS	
Type / Rating	Form C (SPDT), Rated 5 amps 240 VAC max, (1200 VA)
Run Indication	Programmable
At Speed Indication	Programmable
Acceleration Adjustments	Programmable Ramp Types: Voltage or Current Ramp (VR or CR) Starting Torque: 0 - 100% of line voltage (VR) or 0 - 600% of motor FLA (CR) Ramp Time: 1 to 120 seconds Current Limit: 200 - 500% (VR or CR) Power Ramp: 0 – 300%
Dual Ramp Settings	4 Options: VR1+VR2; VR1+CR2; CR1+CR2; CR1+VR2 Dual Ramp Control: Ramp 1 = Default Ramp 2 = selectable via dry contact input
Deceleration Adjustments	Begin Decel Level: 80 - 100% of line voltage Stop Level: 0 to 1% less than Begin Decel Level Decel Time: 1 - 60 seconds
Jog Settings	Voltage Jog: 5 - 75%
Kick Start Settings	Kick Voltage: 10 - 100% Kick Time: 0.1 - 2 seconds
Fault Display	Shorted SCR, Phase Loss, Shunt Trip, Phase Imbalance Trip, Overload, Overtemp, Overcurrent, Short Circuit, Load Loss, Undervoltage or Any Trip
Lockout Display	Coast Down Time, Starts Per Hour, Time Between Starts, and Any Lockout

EVENT HISTORY	
Up to 60 Events	Data includes cause of event, time, date, voltage, power factor and current for each phase and ground fault current at time of event

METERING FUNCTIONS	
Motor Load	Percent of FLA
Current Data	A, B, C Phase Current, Avg Current, Ground Fault (Option)
Thermal Data	Remaining thermal register; thermal capacity to start
Start Data	Avg Start Time, Avg Start Current, Measured Capacity to start, time since last start.
RTD Data (Option)	Temperature readings from up to 12 RTDs (6 stator RTDs)
Voltage Metering	kW, kVAR, PF, kWh

SERIAL COMMUNICATIONS	
Protocol	Modbus RTU
Signal	RS-485, RS-422 or RS232
Network	Up to 247 devices per mode
Functionality	Full operation, status view, and programming via communications port

OPERATOR INTERFACE	
LCD Readout	Alpha numeric LCD display
Keypad	8 function keys with tactile feedback
Status Indicators	12 LEDs include Power, Run, Alarm, Trip, Aux Relays
Remote Mount Capability	Up to 1000 circuit-feet from chassis (Use twisted, shielded wire & power source)

CLOCK and MEMORY	
Operating Memory	SRAM loaded from F-RAM at initialization
Factory Default Storage	Flash Memory
Customer Settings and Status	Non-volatile F-RAM, no battery backup necessary
Real Time Clock	Lithium ion battery for clock memory only

1.3 Reference Chart

SEC.	Table or Drawing	Page Number	SEC.	Table or Drawing	Page Number	
1.2	Specifications	1 - 2	5.2	Setpoint Page 7 Displays - Custom Acceleration Curve	52 - 54	
1.4	Design Features (Unit PIV Ratings)	4		Setpoint Page 8 Displays - Overload Curve Configuration	55 - 56	
1.9 & 4.1	Electronics (Keypad Operator Interface)	8 & 26		Setpoint Page 9 Displays - RTD Option Configuration	57 - 59	
2.2	TCB Board Layout and Connections	10		Setpoint Page 10 Displays - Set Password	60	
	TB1, TB2 & TB3 Description	12		Setpoint Page 11 Displays - Communications	60	
	TB4, TB5 & TB6 Description	13		Setpoint Page 12 Displays - System Setpoints	61 - 62	
	TB7 & TB8 Description	14		Setpoint Page 13 Displays - Calibration & Service	63	
	Jumper Selections	15		6.1	Metering Page List	64 - 65
	Switch Settings	15		6.2	Metering Menu	66
	LED Indicators	16			Metering Page 1 Displays - Metering Data	67
2.3	Optional RTD Board	17	Metering Page 2 Displays - Metering		68	
	Communications Board Layout & Connections: RS485 and RS422	17	Metering Page 3 Displays - RTD Values		69	
	Power Board & Connections	18	Metering Page 4 Displays - Status		70	
	CPU Board Layout & Connections	19	Metering Page 5 Displays - Event Recorder		71	
2.4	Typical Wiring Diagram	20	Metering Page 6 Displays - Last Trip		72	
3.2	Acceleration Adjustments	21	Metering Page 7 Displays - Statistics		73	
3.3	Deceleration Adjustments	22	7.1	Failure Analysis & Troubleshooting	74 -76	
3.4	Sequence of Operation	23	7.1	SCR Testing Procedure	77	
4.2	Menu Navigation	27	<i>NOTES-</i>			
	Changing Setpoints Example	25				
5.1	Setpoints Page List	29 - 35				
5.2	Setpoint Menu & Parameter Explanation	36 - 65				
	Setpoint Page 1 Displays - Basic Configuration	36				
	Overload Class Trip Curves	37				
	Setpoint Page 2 Displays - Starter Configuration	37-42				
	Jog/Voltage Ramp	39				
	Setpoint Page 3 Displays - Phase & Ground Settings	41				
	Overcurrent Trip Delay Graph	43				
	Setpoint Page 4 Displays - Relay Assignment	47 - 42				
	Setpoint Page 5 Displays - Relay Configuration	48				
	Setpoint Page 6 Displays - User I/O Configuration	49 - 51				

1.4 Design Features

The standard Soft Start panel has the following features:

- **SCR Power Modules:** For each phase, the SCRs are arranged in inverse parallel pairs and series *strings* as indicated in Table 1 below to facilitate sufficient Peak Inverse Voltage ratings for the application
- **RC Snubber Networks:** Provide Transient Voltage Protection for SCR Power Modules in each phase to avoid dv/dt damage.
- **Firing Circuit:** The SCRs are gated (turned on) using a Sustained Pulse Firing Circuit. This circuitry is isolated from the control voltage by means of fiber optics.

Table 1 Unit PIV Ratings

100, 200, 400, 600 Amps Units				100, 200, 320, 600 Amps Units			
Voltage	Series Devices	Total Number of SCRs	PIV Rating	Voltage	Series Devices	Total Number of SCRs	PIV Rating
10kV – 11kV	6	36	27000V	13.2 – 13.8kV	6	36	39000V

1.5 Theory of Operation

The Soft Starter is CPU controlled, using a microprocessor based protection and control system for the motor and starter assembly. The CPU uses Phase Angle Firing control of the SCRs to apply a reduced voltage to the motor, and then slowly and gently increases torque using voltage and current control until the motor accelerates to full speed. This starting method lowers the starting current of the motor, reducing electrical stresses on the power system and motor. It also reduces peak starting torque stresses on both the motor and mechanical load, promoting longer service life and less downtime.

1.5.1 Acceleration:

The soft starter comes standard with several methods of accelerating the motor so that it can be programmed to match almost any industrial AC motor application. The factory default setting applies a **Voltage Ramp** with **Current Limit** as this has been proven to be the most reliable starting method for the vast majority of applications. Using this starting method, the Initial Voltage setting applies just enough voltage to cause the motor shaft to begin to turn. This voltage is then gradually increased over the "Ramp Time" setting, until one of two things happen: the motor accelerates to full speed, or the Ramp Time expires and the Current Limit setting is reached.

If the motor accelerates to full speed before the ramp time has expired, an automatic Anti- Oscillation feature will override the remaining ramp time and full voltage will be applied. This will prevent any surging or pulsation in the motor torque, which might otherwise occur. If the motor has not reached full speed at the end of the ramp time setting, the current limit setting will proportionally regulate the maximum output torque. CPU algorithms provide protection against a stall condition, an overload condition or excessive acceleration time.

The Current Limit feature is provided to accommodate installations where there is limited power available (For example, on-site generator power or utility lines with limited capacity). The torque is increased until the motor current reaches the pre-set Current Limit value at which point it is then held. Current Limit overrides the ramp time setting so if the motor has not accelerated to full speed under the Current Limit setting, the current remains limited for as long as it takes the motor to accelerate to full speed.

When the motor reaches full speed and the current drops to running levels, the soft starter detects an At-Speed condition and automatically closes the Bypass Contactor. The Bypass Contactor serves to shunt power around the SCR stack assemblies to prevent heat build-up in the starter enclosure. At this point, the motor is operating at full voltage, speed and power.

Other starting methods available in the soft starter are:

- **Current Ramp:** Uses a closed loop current feedback algorithm to provide a linear current increase up to a Maximum Current level.
- **Constant Current:** current is immediately increased to the Current Limit point and held there until the motor reaches full speed.
- **Power (KW) Ramp:** Uses a True RMS KW feedback PID loop to provide a linear increase in True RMS motor power to a maximum set KW value.
- **Custom Curve:** Gives the user the ability to plot torque and time points on a graph. The soft starter will then accelerate the motor following these points.
- **Tachometer Feedback Ramp:** uses a closed loop speed follower method monitoring a tachometer input signal from the motor or load shaft to provide a linear RPM acceleration.

1.5.2 Deceleration: The soft starter provides the user with the option of having the load coast to a stop or controlling the deceleration by slowly reducing the voltage to the motor upon initiating a stop command. The Decel feature is the **opposite of DC injection braking** in that the motor will actually take longer to come to a stop than if allowed to coast to a stop. The most common application for the Decel feature is pumping applications where a controlled stop prevents water hammer and mechanical damage to the system.

1.6 General Protection

The Soft Starter is provided with a built-in motor protection relay that can be programmed for primary protection of the motor / load system. Operation of the Soft Starter can be divided into 4 modes; Ready, Start, Run and Stop.

1.6.1. Ready Mode: In this mode, control and line power are applied and the Starter is ready for a start command.

Protection during this mode includes the monitoring of current for leakage through multiple shorted SCRs or welded contacts on the Bypass Contactor. Other protection features in effect are:

- Starter Power Pole Temperature
- Shorted SCR
- Blown Fuse Indication
- Phase Reversal (if enabled)
- Line Frequency Trip Window
- External Input Faults (Digital Input Faults are active in all modes)
- Undervoltage
- Overvoltage

Note: The “Programming Mode” can only be entered from the Ready Mode. Any attempt to enter data while the motor is starting or running will be blocked. During programming, all protection features and start command are disabled.

1.6.2 Start Mode: These additional protection functions are enabled when the Soft Starter receives a valid Start command:

- Phase Reversal (if enabled) Phase Reversal will still be on and is not a newly activated feature when starting.
- Start Curve
- Acceleration Timer
- Phase Imbalance
- Short Circuit / Load Pre-check (Toe-in-the-Water)
- Ground Fault (Optional)
- External Input Faults
- Accumulated Starting FLA Units (I2t Protection)
- Starting Overload Protection Curve Selection
- Thermal Capacity

Note: Shorted SCR protection is no longer in effect once the soft starter goes into the Start Mode.

1.6.3 Run Mode: The soft starter enters the Run Mode when it reaches full output voltage *and* the motor current drops below the FLA setting (motor nameplate FLA plus service factor) for a pre-determined period of time. During the Run Mode these additional protection features are enabled:

- Running Overload Protection Curve Selection
- Phase Loss
- Under Current / Load Loss
- Over Current / Electronic Shear Pin (Jam Protection)
- External Input Faults

1.6.4 Stop Mode: Once a Stop command has been given, the protection features change depending on which Stop Mode is selected.

- Decel Mode: Retains all protection features of the Run Mode. At the end of Decel, the motor will be stopped and the protection features change as indicated below.
- Coast-To-Stop Mode: Power is immediately removed from the motor and the Soft Starter returns to the Ready Mode.
- Additional protection features activated when the stop command is given include:
 - Coast-Down / Back Spin Timer
 - Starts-per-Hour
 - Time between Starts
 - External Input Faults

1.7 Thermal Overload Protection

The Soft Starter plays an important role in the protection of your motor in that it monitors the motor for excessive thermal conditions due to starting, running and ambient conditions. The soft starter has a Dynamic Thermal Register system in the CPU that provides a mathematical representation of the thermal condition of the motor.

This thermal information is retained in memory and is monitored for excesses in both value and rate of change. Inputs are derived from current values, imbalances and (optional) RTD measurements making it dynamic to all processes involving the motor. The Soft Starter monitors these conditions separately during the Start and Run modes to provide proper thermal protection at all times.

1.7.1 Start Mode overload protection is selectable using one of three methods:

- **Basic Protection:** I²t data is accumulated and plotted based on an Overload Curve selected in programming. This is programmed per NEMA Class 5-30 standard curves and is based on the Locked Rotor Current (from the motor nameplate) as programmed into the Soft Starter.
- **Measured Start Capacity:** The user enters a measured amount of thermal capacity from a pre-selected successful start as a set point to the Thermal Register for the soft starter to follow.
- **Learned Curve Protection:** The user sets the soft starter to the “LEARN” mode and starts the motor under normal starting conditions. The CPU then samples and records 100 data points during the start curve, analyzes them and creates a graphical representation in memory. The soft starter is then switched to Curve Follow protection mode and monitors motor performance against this curve. This feature is especially useful in initial commissioning tests to record a base line performance sample (In this case, it is not necessarily used for motor protection).

1.7.2 Run Mode overload protection is initiated when the soft starter determines that the motor is At-Speed. Overload Protection is initiated when the motor RMS current rises above a “pick-up point” (as determined by the motor nameplate FLA and service factor). Run mode protection is provided by the CPU monitoring the Dynamic Thermal Register. Data for the Dynamic Thermal Register is accumulated from I²t calculations and cooling rates. A trip occurs when the register reaches 100% as determined by the selected Overload Protection Curve (NEMA Class 5-30 standard curves) and is based on the programmed Locked Rotor Current indicated on the motor nameplate. The Dynamic Thermal Register is altered, or “biased”, by the following conditions:

- **Current Imbalance** will bias the register higher due to additional motor heating as a result of a line current imbalance condition.
- **Normal Cooling** is provided when the motor current drops below the overload pick-up point or the motor is off line. The Cooling rate is lower for motors that are off-line (such as after a trip) since cooling fans are also inoperative.
- **RTD Input** (Requires the optional RTD monitor card) provides a separate means of motor protection based on actual temperatures measurements inside the motor. It runs independently of the Thermal Register Model and does not provide input to, or bias that model.
- **Dynamic Reset** is another feature that adds reliability and consistency to the performance of the soft starter. If a motor overload condition occurs and the Overload protection trips, it cannot be reset until sufficient cool down time has elapsed. This cool down time is determined by the "Learned Thermal Capacity" required to start the motor which must be regained before the overload can be reset. This ensures sufficient thermal capacity for a successful restart of the motor.
- **Retentive Memory** provides continuous overload protection and true thermal modeling by means of a running back up of the thermal register even if power is lost. Upon restoration of power, the soft starter will read the Real Time Clock, then recalculate and restore the thermal register to what it should be, given the elapsed time and the cool down rate of the motor.
- **Learned Reset Capacity** is a feature that is unique to the Soft Starter. By sampling the amount of thermal capacity used in the previous three successful starts, the starter will not allow a reset until a sufficient amount of thermal capacity has been regained in the motor. This prevents nuisance tripping and insures that unsuccessful start attempts (which would otherwise use up the starts-per-hour capacity of the motor) are not counted.

1.8 Firing Circuit

The SCR gate firing circuit is critical to the performance and stability of the system. The firing circuit includes several unique features which enhance the ruggedness, noise immunity and flexibility for maximized performance. These features include:

- **Auto Synchronizing** of the gate timing pulses match each phase firing angle to their respective phases. The Soft Starter actively tracks minor shifts in the line frequency avoiding nuisance tripping that may happen with conventional gate firing systems. This is especially useful on portable or backup generator supplies, allowing the soft starter to be used confidently in applications that have unstable power.
- **Sustained Pulse** firing keeps the firing signal active for 270 electrical degrees ensuring that the DC gate pulse forces the SCR to fire even if line noise is present. This provides the Soft Starter with superior noise immunity and protects against misfiring, enhancing the soft starter system stability.
- **Closed Loop Firing Control** is a method of balancing the SCR firing pattern. The CPU uses feedback signals from the output current and voltage providing to provide smooth output preventing imbalances during ramping which prevents unnecessary motor heating.
- **Transformer Isolation** of SCR firing information and signals prevents interference from line noise and EMI/RFI that may be present. Three phase isolation transformers provide potential measurement, firing board timing while providing isolation from the line voltage. High isolation Ring Transformers are used to step the 120v control voltage down to 28VAC for the Sustained Pulse firing circuit, providing further isolation for the SCR gates.
- **Fiber Optic Isolation** is provided for all gate drive and current feedback signal interfaces between the Medium and Low Voltage systems.

1.9 Electronics

The Soft Starter electronic systems are divided into two categories; Low Voltage and Medium Voltage and are based on where they are located in the Starter structure.

1.9.1 Low Voltage electronics include the Keypad Operator Interface, the CPU and Main Power PC boards which are located in an isolated Low Voltage compartment of the enclosure.

- **Keypad Operator Interface** is a 2 line x 20 character LCD display with back-lighting for low ambient light conditions. The display reads out in truncated English and can show multiple data points in each screen. Twelve LED indicators are included which show the status of, Power, RUN, ALARM, TRIP and the 8 AUX RELAYS. The Operator communicates with the CPU board via a serial cable link and can be remotely located up to 1000ft. from the starter. **FIG. 1.9** shows the Keypad Operator Interface.

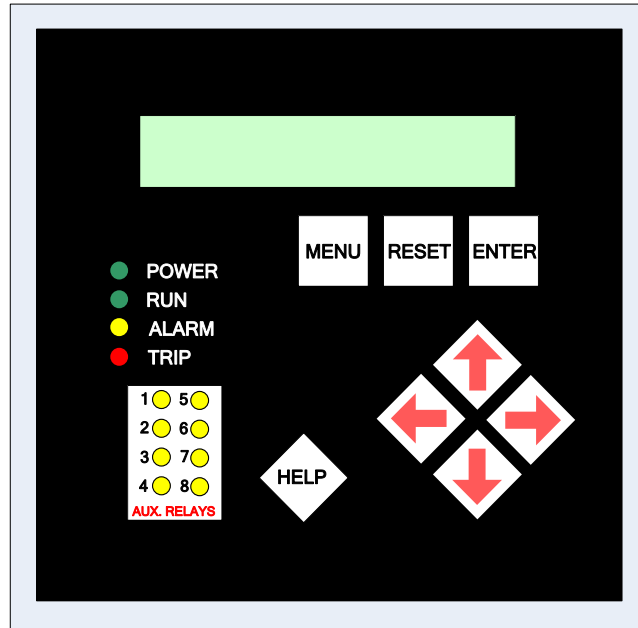
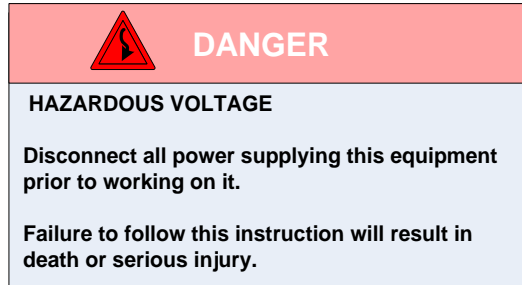

FIG. 1.9 Keypad Operator Interface.

- **CPU Board** is where the microprocessor and communications co-processor are located. It is attached to the main Power board. The CPU determines operating functions, stores user programming, acts upon feedback signals for faults, and calculates metering and historical data. The board communicates with the Keypad Operator Interface via a serial link cable. Analog and Digital I/O are also located on the CPU board. (See **FIG. 2.3.4**)
- **Main Board** also referred to as the Firing Board, contains the Auxiliary I/O relays and interfaces to the TCB board (see below) for user interface. This board generates all firing signals for the SCR stacks and receives feedback signals which are isolated via fiber optics. The board also provides signal conditioning in preparation for analog to digital conversion. (See **FIG. 2.3.3**)

1.9.2 Control Electronics are located in the Medium Voltage section of the soft starter. They include the Gate Drive and Temp / CT boards.



- **TCB (Terminal and Control Board)** is the user connection interface board. This board contains the user terminal blocks, output relays (duplicated), inputs and control power connections. It also contains additional timed relays for interfacing with Power Factor Correction contactors (if used) and other external devices. Please note Power Factor Capacitor warnings in **Section 2.1.**; also see **FIG. 2.2.1.**
- **Gate Drive Boards** are located directly on the SCR stacks. These boards connect to the Main Power board via fiber optic cables. They amplify the gate pulse signals with power from the Ring Transformers to create the Sustained Pulse Firing of the SCRs. There is one Gate Drive board for each pair of SCRs in each stack.
- **Temp / CT Boards** are attached to the Gate Drive boards on the SCR stacks and provide the heat sink Temperature and line current signals back to the Main Power Board via fiber optic cables.
- **MOV Boards** are attached to standoffs mounted on the SCR heat sinks and are mounted directly below the Gate Drive boards. The MOV boards are used to protect the SCRs from over voltage.
- **DV/DT Boards** are also attached to standoffs mounted on the SCR heat sinks and are mounted below the MOV boards. The DV/DT boards are used to mitigate voltage transients across the stack assemblies.

Chapter 2 – Connection

2.1 Warnings

- **Do not service this equipment with voltage applied!** The unit can be the source of fatal electric shock! To avoid shock hazard, disconnect main power and control power before working on the unit. Warning labels must be attached to terminals, enclosure and control panel to meet local codes observing Lock Out, Tag Out procedures.
- **Do not connect (PFC) capacitors or surge capacitors to the load side (motor side) of the unit.** This will cause di/dt damage to the SCRs when they are turned on and will void the warranty on this product. Capacitors can only be connected to the load side of the starter through the use of an isolating contactor which is closed after the soft starting sequence has been completed or when di/dt limiting inductors are factory installed.
- **Avoid connecting capacitors to the input side of the unit.** If you cannot avoid using capacitors across the power lines, they must be located as far upstream as possible of the input line contactor. In this situation, an optional power factor correction (PFC) capacitor contactor should be specified. For additional information and specifications or when di/dt limiting inductors are factory installed, please contact the factory.
- **Never interchange the input and output power connections on the unit.** This will cause excessive voltage to the control circuit logic.
- **For bus protection, it is strongly recommended to use non-gap MOV Type lightning arrestors in areas where lightning is a significant problem.** The arrestors should be mounted on the nearest utility pole at the Station or optionally included with the unit at the time of order.
- **Medium Voltage cables can have significant capacitance values by design which can elevate Di/Dt thru the SCRs to unsafe levels.** Compensating inductors can limit these values to safe levels. Contact the factory if you need more information on this subject.



DANGER

HAZARDOUS VOLTAGE

Disconnect all power supplying this equipment prior to working on it.

Failure to follow this instruction will result in death or serious injury.



CAUTION

SCR DAMAGE

Do not connect (PFC) capacitors to the load side of the unit.

Doing so will cause DI/DT damage to the SCRs when energized.



WARNING

SAFETY HAZARD

Do not bypass electrical or mechanical interlocks.

Failure to follow this instruction will cause severe equipment damage, serious injury or death.

2.2 Control Connections - TCB (Terminal and Control Board)

2.2.1 TCB Board

The TCB board, FIG. 2.2.1 shown below, provides interconnections between the main power and CPU boards and the customer's control logic connections. It is a 120 VAC control board with several auxiliary dry contacts, built-in time delay circuits and an emergency bypass function. It also controls the inline isolation and bypass contactor and provides provisions for shutdown interlocks. (See **Section 2.2.2** for terminal designations and descriptions)

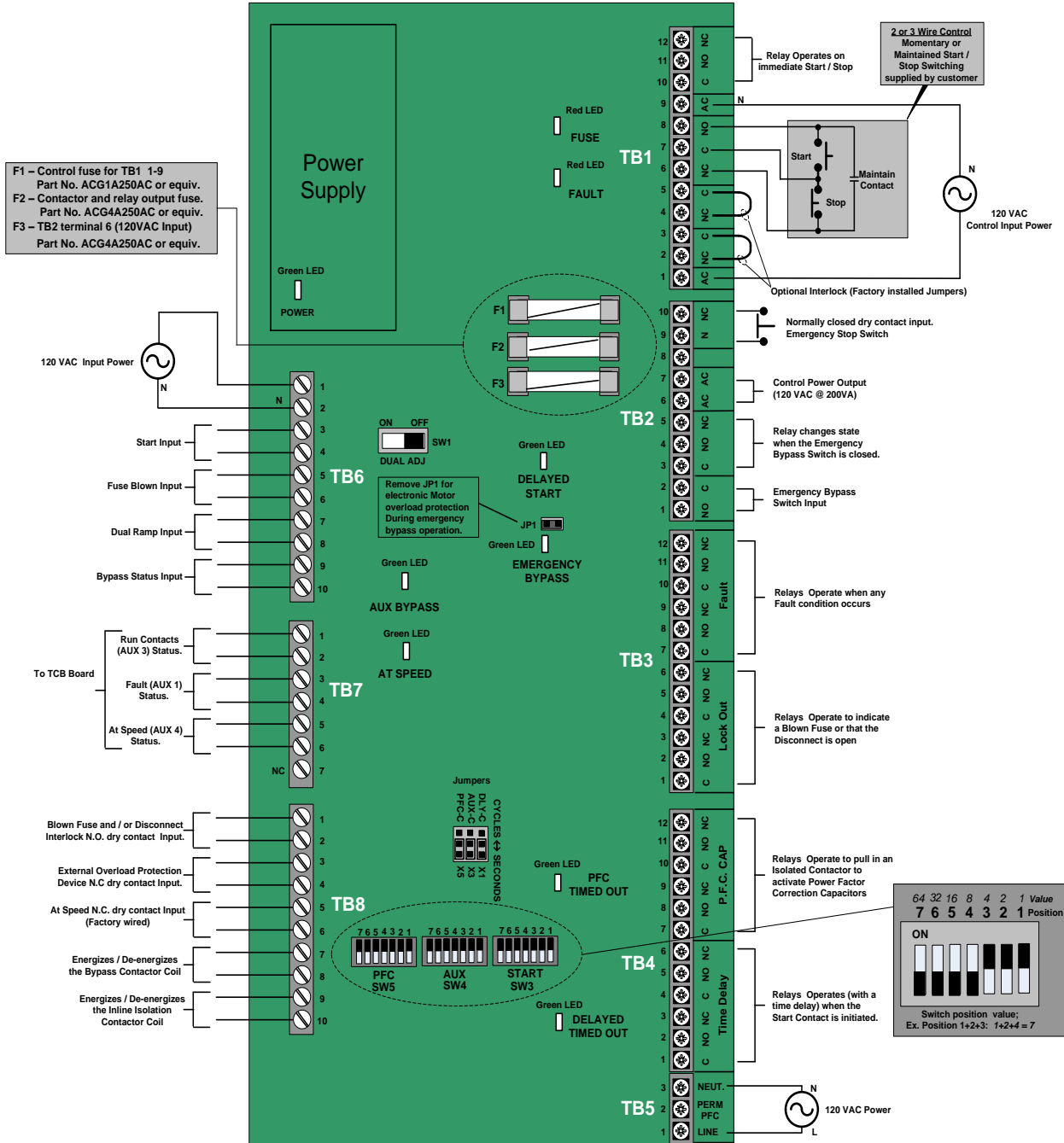

FIG. 2.2.1 TCB Terminal and Control Board

2.2.2 Description of Terminal Connections

TB1 Start / Stop Control		
T	Description	
1	AC	120 VAC Control Power (Line)
2 3	NC C	Shutdown Input – Accepts customer N.C dry contact (Factory jumper installed)
4 5	NC C	Shutdown Input – Accepts customer N.C dry contact (Factory jumper installed)
6 7 8	NC C NO	Terminal 6, 7 & 8; "2-wire control is connected to pins 6 & 8". Also; "For 3 wire control, connect the N.C. STOP button to pins 6 & 7 and the N.O. START button to pins 7 & 8
9	AC	120 VAC Control Power (Neutral)
10	C	Common
11	NO	Normally Open
12	NC	Normally Closed, Form C Relay that changes state on Start and Stop commands

TB2 Emergency Bypass Control		
T	Description	
1 2	NO C	When the N.O. contact closes the unit reverts to an electromechanical starter. When a start command is given the unit will start the motor across the line.
3 4 5	C NO NC	Terminals 3, 4 and 5 is a form C output relay that changes state when the contact at TB2 pins 1 & 2 is closed
6 7	NO NC	120 VAC @ 200VA Aux Control Power output.
8	-	Not Used
9 10	N NC	Normally Closed Emergency Stop Dry Contact Input. Open to activate the Emergency Stop Feature.

TB3 Fault Relay Outputs		
T	Description	
1 2 3	C NO NC	(2) Form C relay output that transfer on blown fuse or disconnect open indication.
4 5 6	C NO NC	(2) Form C relay output that transfer on blown fuse or disconnect open indication.
7 8 9	C NO NC	(2) Form C relay output that transfer on any fault indication.
10 11 12	C NO NC	(2) Form C relay output that transfer on any fault indication.

2.2.2. Description of Terminal Connections - Continued

TB4 Optional Relay Outputs		
T	Description	
1 2 3	C NO NC	2 Form C time delay Aux relay output contacts. Time delay starts when the Start commend is given.
4 5 6	C NO NC	
7 8 9	C NO NC	2 Form C time delay Aux relay output contacts. Time delay starts when the "At Speed" condition is reached ideal for controlling a PFC contactor.
10 11 12	C NO NC	

TB5 TCB Power		
T	Description	
1	L	By connecting TB5 of multiple units in parallel, PFC contactors will be inhibited from closing while a unit is soft starting. PFCs that are already on line will remain on line. The lead unit in the parallel string requires TB5 pins 1 & 3 to be connected to the 120Vac source and neutral respectively.
2	PFC	
3	N	

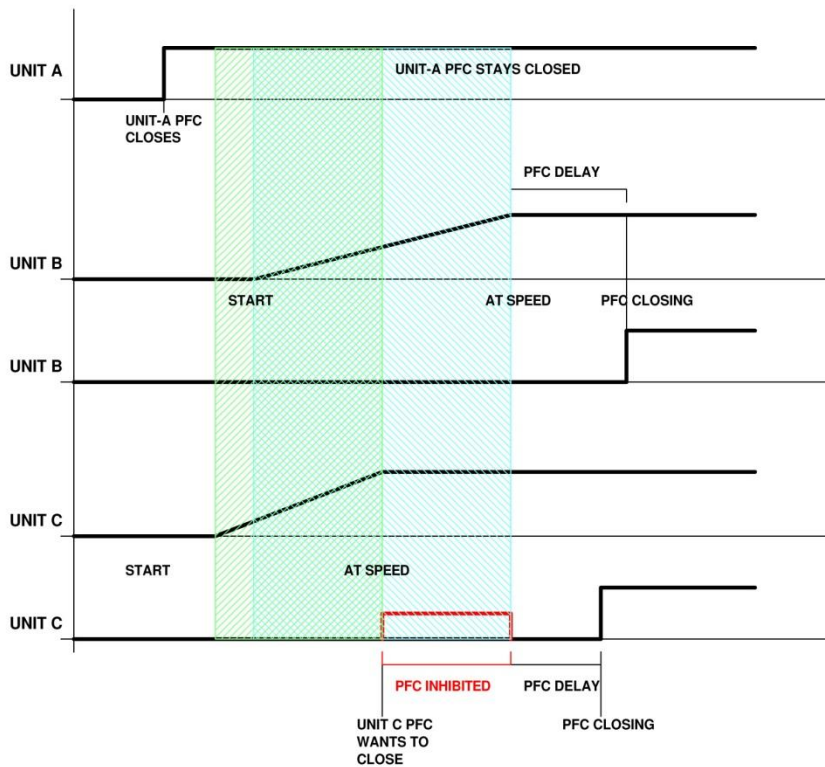

Example: PFC Automatic inhibit control

2.2.2 Description of Terminal Connections - Continued

TB6 Main and CPU Circuit Board Control Inputs		
T	Description	
1 2	L N	120 Vac output to Control Power Input (Main & CPU Circuit)
3 4	- -	Start Input
5 6	- -	Fuse Blown Input
7 8	- -	Dual Ramp Input
9 10	- -	Bypass Status Input

TB7 Main and CPU Circuit Board Control Outputs		
T	Description	
1 2	Run contacts (AUX3) to the TCB board. <i>(Signal is used to hold the Main Contactor closed during deceleration)</i>	
3 4	To the TCB board indicating the status of AUX 1.	
5 6	At Speed Contacts (AUX 4) used to signal the Bypass Contactor to close.	
7	Not Connected / Not Used	

TB8 Control Inputs and Outputs		
T	Description	
1 2	N.C. dry contact input from blown fuse and/or disconnect interlock.	
3 4	N.C. dry contact input from an external Overload Protection device. <i>(Required if emergency bypass is used)</i>	
5 6	N.C. dry contact input from the Bypass Contactor for at speed indication.	
7 8	Output connected to the Bypass Contactor and energizes / de-energizes the Contactor. <i>(Factory wired)</i>	
9 10	Output connected to the Inline Isolation Contactor and energizes / de-energizes the Contactor. <i>(Factory wired)</i>	

2.2.3 Description of Jumper Selections and Functions

Jumper Selection			
Jumper		Time Delay	Function
DLY-C	X1	Seconds /Cycles	Start Delay Jumper selects between seconds or cycles (1/60 th of a second) for the start delay when a Start command is received and when the CPU actually receives the start signal. Default jumper setting is seconds.
AUX-C	X3	Seconds /Cycles	Auxiliary (Start) Delay Jumper selects between seconds or cycles (1/60 th of a second) for the auxiliary start delay when a Start command is received and when the CPU actually receives the start signal. Default jumper setting is seconds.
PFC-C	X5	Seconds /Cycles	PFC Contactor Delay Jumper selects between seconds or cycles (1/60 th of a second) for the delay when the Bypass Contactor closes to when the Power Factor Capacitors Contactor is activated. Default jumper setting is seconds.
JP1		N/A	Motor Protection Jumper When this jumper is in place, the CPU will be disabled during operation in the Emergency Bypass Mode. <i>In this case, insure that there is an external means of overload protection.</i> When the jumper is removed, the CPU will be enabled to provide electronic motor protection when operating in the Emergency Bypass Mode.

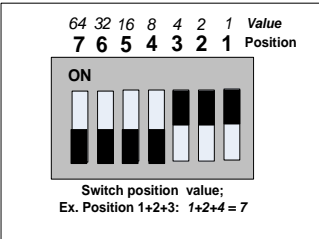
DIP Switches		
Switch	Function	
SW1	ON: Sets Dual Adjustment OFF: Disabled	
SW2	Not Used	
SW3	Sets the Start Delay Value	<p>SW3, SW4 and SW5 are 7 position DIP Switches that use binary coding to set the value of the time delay in Cycles or Seconds as selected via jumpers X1 to X6. (See Jumper Table.) The setting range is 0 to 127 (1+2+4+8+16+32+64). The example shown results in a value of 7 (1+2+4)</p> 
SW4	Sets the AUX Start Delay Value	
SW5	Sets the PFC Contactor Delay Value	

2.2.5 Description of LED Indicators Functions

LED Indicators			
Function	Location	Color	Function
Fuse Blown/ Disconnect	D4	Red	ON: When a Fuse is blown and / or a Disconnect is open.
Fault	D16	Red	ON: When any Fault has occurred.
Start	D7	Yellow	ON: When a Start signal has been initiated.
PFC Timed Out	D17	Yellow	ON: When the Power Factor Correction Capacitors Contactor is energized.
Delay Timed Out	D15	Yellow	ON: When the Auxiliary Start Contacts have been energized.
+24V	D28	Green	ON: +24V supply is good.

2.3 PCB Layout Section - THIS SECTION IS FOR REFERENCE ONLY. NO FIELD WIRING OR CONNECTIONS ARE REQUIRED.

2.3.1 Optional RTD Board

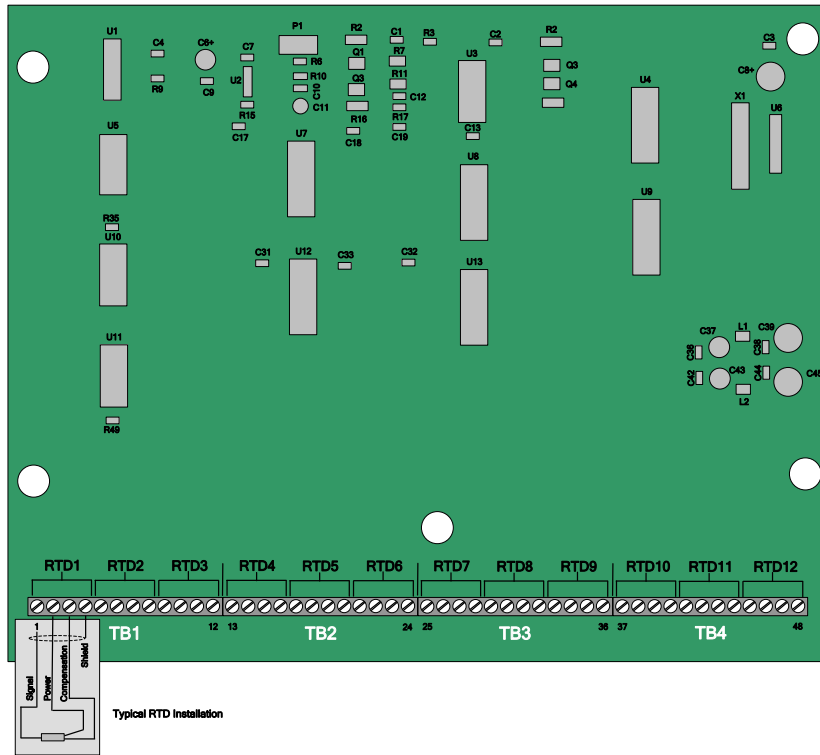

FIG. 2.3.1 Optional RTD Board

2.3.2 RS485 / RS422 Communications Board

Note: This Board is mounted on the back of the Keypad Interface

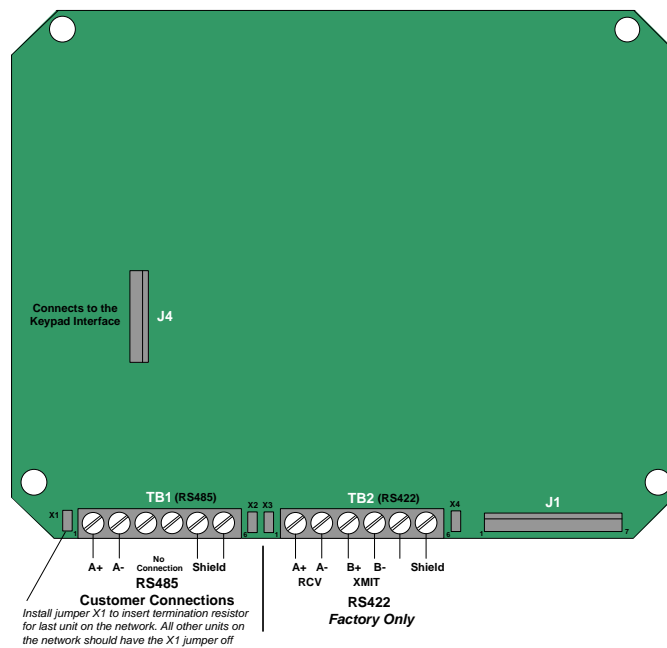

FIG. 2.3.2 RS485 / RS422 Communications Board

2.3.3 Main Board

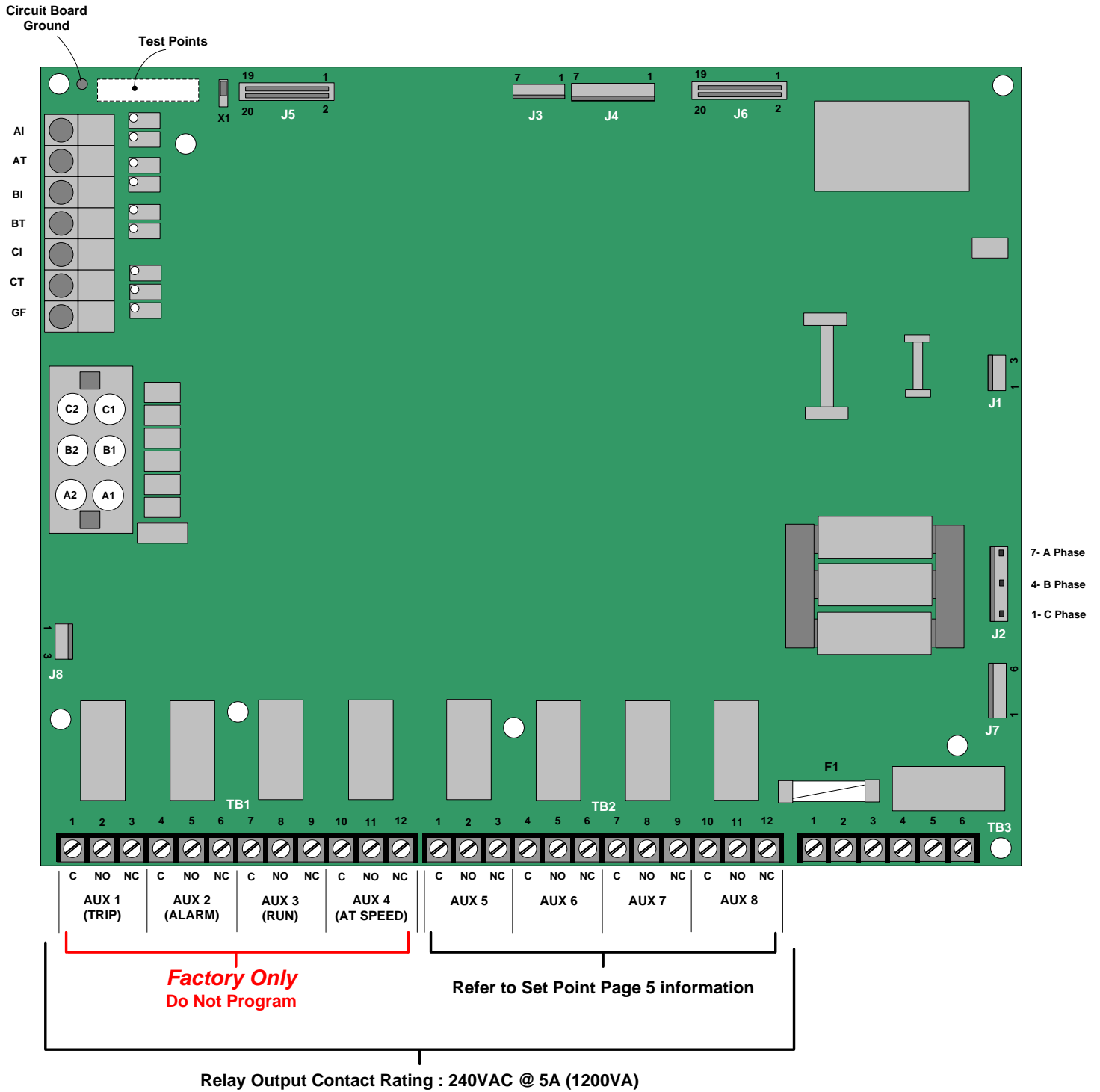

FIG. 2.3.3 Power Board

2.3.4 CPU Board

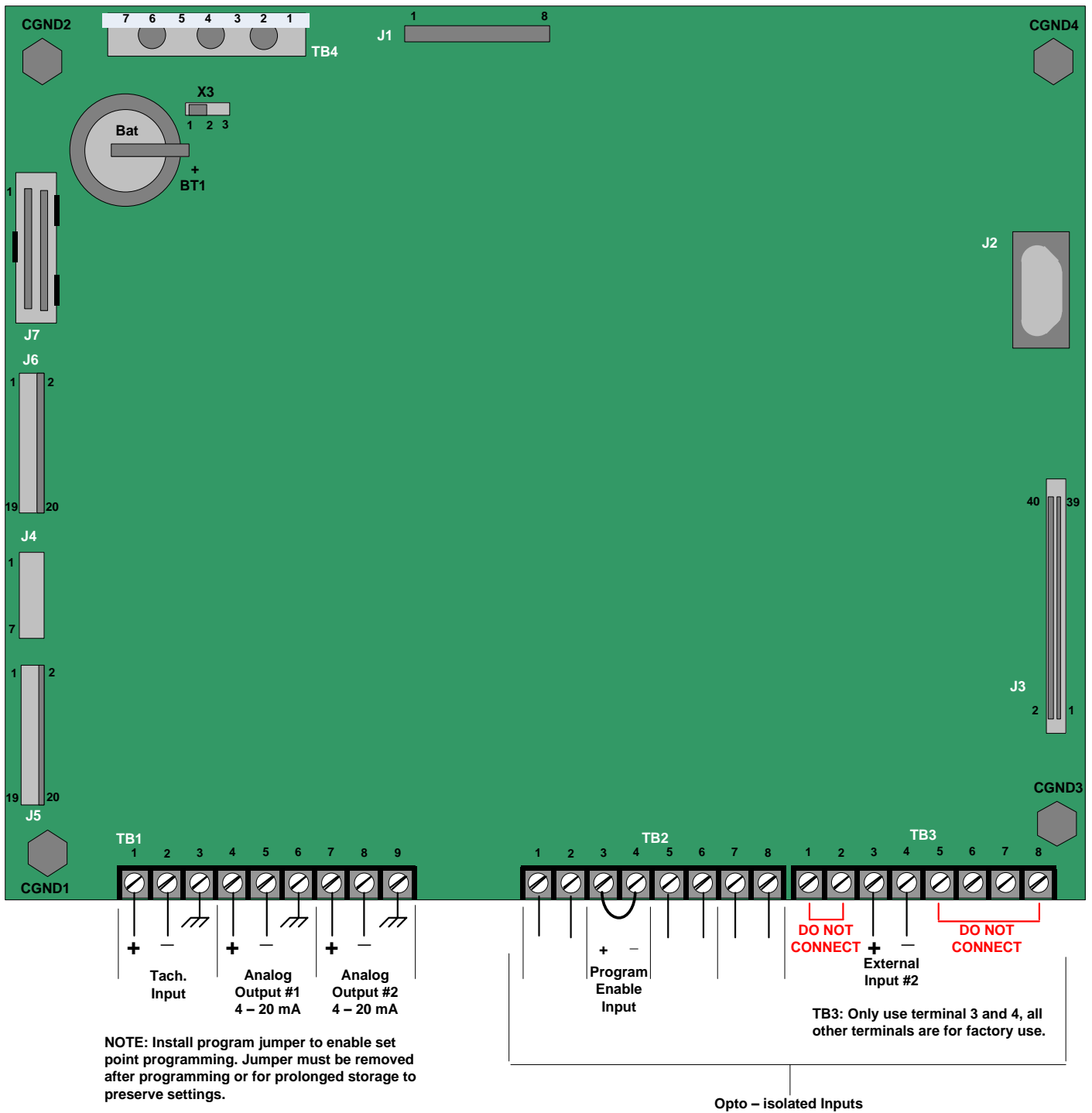

FIG. 2.3.4 CPU Board

2.4 Typical Wiring Diagram

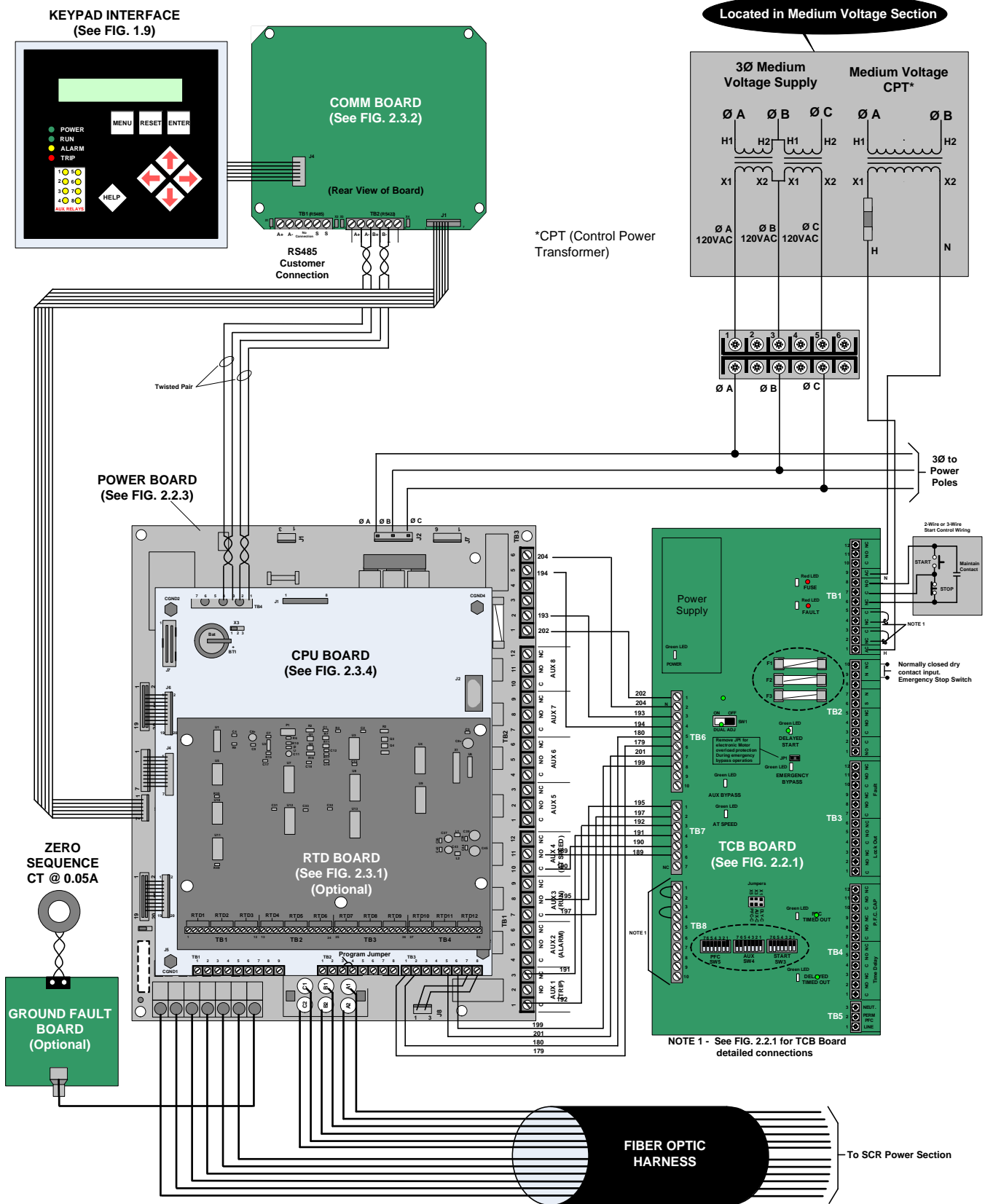

FIG. 2.4 Typical Wiring Diagram

Chapter 3 - Start-up

3.1 Introduction

It is best to operate the motor at its full load starting condition to achieve the proper settings. Initial settings are set to accommodate most motor conditions. **TRY INITIAL SETTINGS FIRST.** See Section 5.1.2 Starter Configuration (Set Point Page 2) to make any adjustments.

3.2 Acceleration Adjustments

The unit is set at the factory with typical starting characteristics that perform well in most applications. When the system is ready to start, try the initial settings. If the motor does not come up to speed, increase the current limit setting. If the motor does not start to turn as soon as desired, raise the Initial voltage adjustment. Adjustment description and procedures are described as follows. See Section 5.1.2 Starter Configuration (Set Point Page 2) for additional Accel settings.

3.2.1 Initial Voltage

Factory Setting = 20% of line voltage
Range = 0% - 100% of line voltage

Initial voltage adjustment changes the initial starting voltage level to the motor.

3.2.2 Ramp Time

Factory Setting = 10 sec.
Range = 0 - 120 sec.

Ramp time adjustment changes the amount of time it takes to reach the current limit point or full voltage if the Current limit point was not reached.

Note: Refer to your motor manual for the maximum number of starts per hour allowed by the manufacturer and do not exceed the recommended number.

3.2.3 Current Limit (see FIG. 3.2.3)

Factory Setting = 350% of motor FLA
Range = 200% - 500% of motor FLA

The main function of current limit is to limit the maximum current. It may also be used to extend the ramp time if required. The interaction between the voltage ramp and the current limit will allow the soft start to ramp the motor until the maximum current is reached and the current limit will hold the current at that level. The current limit must be set high enough to allow the motor to reach full speed. The factory setting of 350% is a good starting point.

Do not set the current limit too low on variable starting loads. This could cause the motor to stall and eventually cause the overload protection to trip.

Note: If the motor does stall, refer to the motor manufacturer's motor data for the proper cooling time.

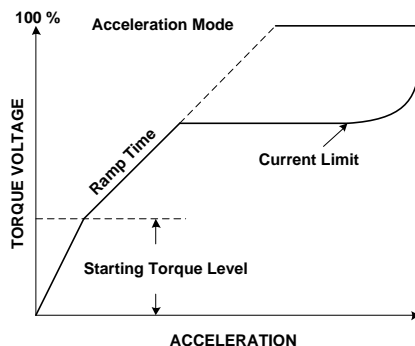

FIG. 3.2.3 Current Limit

3.3 Deceleration Adjustments (Pump Control)

Decel control extends the stopping time on loads that would otherwise stop too quickly when power is removed. Decel control provides smooth deceleration until the load comes to a stop. Three adjustments optimize the deceleration curve to meet the most demanding requirements. **The unit is shipped from the factory with the Decel control feature disabled.**

3.3.1 Deceleration Applications

Apply power and adjust the soft start before enabling or modifying the deceleration adjustments. Both, acceleration and deceleration adjustments should be made under normal load conditions. The deceleration feature provides a slow decrease in the output voltage, accomplishing a gentle decrease in motor torque during the stopping mode. This is the **OPPOSITE OF BRAKING** in that, it will take **longer** to come to a stop than if the starter were just turned off. The primary use of this function is to reduce the sudden changes in pressure that are associated with “Water Hammer” and slamming of check valves with centrifugal pumps. Decel control in pump applications is often referred to as **Pump Control**. In a pump system, liquid is being pushed uphill. The force exerted by gravity on the column of liquid as it goes up hill is called the “Head Pressure” in the system. The pump is sized to provide enough Output Pressure to overcome the Head Pressure and move the fluid up the pipe. When the pump is turned off, the Output Pressure rapidly drops to zero and the Head Pressure takes over to send the fluid back down the hill. A “Check Valve” is normally used somewhere in the system to prevent this (if necessary) by only allowing the liquid to flow in one direction. The kinetic energy in that moving fluid is suddenly trapped when the check valve slams closed. Since fluids can’t compress, that energy is transformed into a “Shock Wave” that travels through the piping system looking for an outlet in which to dissipate. The sound of that shock wave is referred to as “Water Hammer” and the energy in that shock wave can be extremely damaging to pipes, fittings, flanges, seals and mounting systems.

By using the Soft Stop/Deceleration feature of the soft starter, the pump output torque is gradually and gently reduced, which slowly reduces the pressure in the pipe. When the Output Pressure is just slightly lower than the Head Pressure, the flow slowly reverses and closes the Check Valve. By this time there is very little energy left in the moving fluid and the Shock Wave is avoided. When the output voltage to the motor is low enough to no longer be needed, the soft starter will end the Decel cycle and turn itself off. (See **FIG. 3.3**)

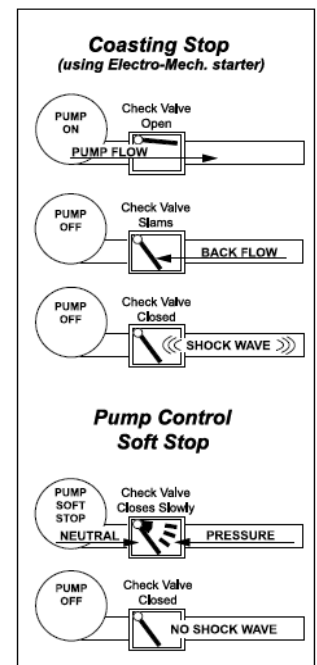
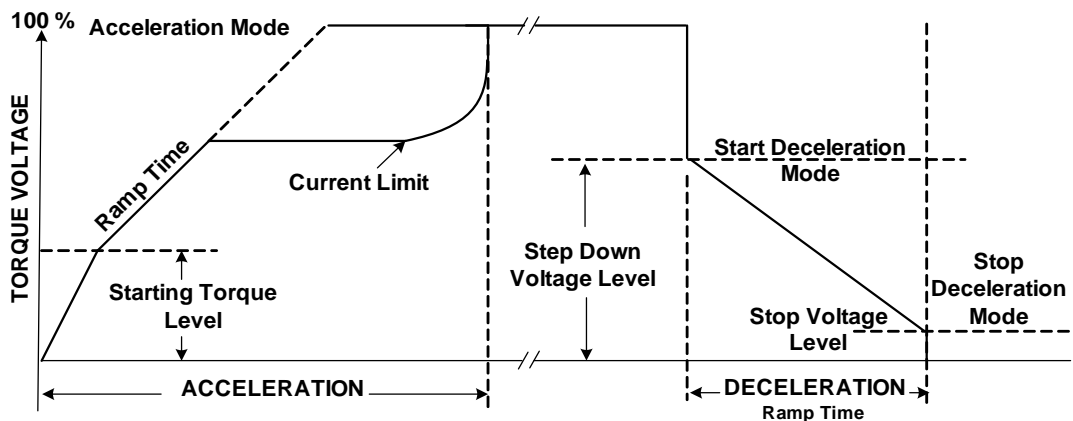

FIG. 3.3 Deceleration Control

Another common application for decel control is on material handling conveyors as a means to prevent sudden stops that may cause products to fall over or to bump into one another. In overhead crane applications, soft stopping of the Bridge or Trolley can prevent loads from beginning to over swing on sudden stops.

3.3.2 Start Deceleration Voltage

Factory Setting = 100% of line voltage
Range = 10% - 100% of line voltage

The step down voltage adjustment eliminates the dead band in the deceleration mode that is experienced while the Voltage drops to a level where the motor deceleration is responsive to decreased voltage. This feature allows for an instantaneous drop in voltage when deceleration is initiated.

3.3.3 Stop Deceleration Voltage

Factory Setting = 30% of line voltage
Range = 0% - 100% of line voltage

The stop voltage level set point is where the deceleration voltage drops to zero.

3.3.4 Deceleration Time

Factory Setting = 5 sec.
Range = 0 - 60 sec.

The deceleration ramp time adjusts the time it takes to reach the stop voltage level set point. The unit should be restarted and stopped to verify that the desired deceleration time has been achieved. When calculating the number of starts per hour, a decel curve should be counted as a start curve. For example, recommended number of starts per hour = 6, allowable starts with decel cycle per hour = 3.

Note: Do not exceed the motor manufacturer's recommended number of starts per hour.

3.4 Sequence of Normal Operation

It is best to operate the motor at its full load starting condition to achieve the proper time, torque and ramp settings. Initial settings are set to accommodate most motor conditions.

TRY INITIAL SETTINGS FIRST FOR:

- Initial Voltage
- Current Limit
- Ramp Time

See section 5.1.2 Set-point Page 2 to make any adjustments. If the Decel function is enabled, related parameters may also need adjusting to achieve optimal Decel performance

Sequence:

- Close the disconnect switch to apply 3 phase power" Verify the power LED on the keypad comes on.

**MOTOR STOPPED
READY TO START**

- Activate the start command, the motor should start accelerating and the RUN LED will come ON.

**MOTOR STARTING
00 x FLA**

**OVERLOAD ALARM
TIME TO TRIP .XXX SECS**

Check: If the motor decelerates, or stops, during the acceleration period, **activate the Stop button immediately.** Adjustments to the ramp time and or current limit setting are necessary to provide the motor sufficient energy to reach full speed. If the unit does not follow this operational sequence, please refer to the Troubleshooting Chapter.

If the motor does not enter the run mode in the set time (Acceleration time limit, see SP8.2), a trip will occur. When the Motor Reaches full speed the At Speed” LED will come on and the Aux 4 (At speed) relay will energize closing the bypass contactor. Phase A, B, C and Gnd Flt current is then shown on the keypad during operation.

IA: ___	IB: ___
IC: ___	GF: ___

3.5 Emergency Bypass Operation

Emergency Bypass (10-13.8kV Class)

- Remove input power by opening the disconnect switch and lock out.

Direct on line starting that will follow the normal start stop signal:

- On the TCB board, connect a wire from TB2- pin 1 to TB4 pin 1 and TB2 pin 2 to TB4 pin 2.

The unit will now allow direct on line starting that will follow the normal start stop signal.

For emergency bypass starting operation local to the unit:

- Connect a normally open Dry contact to the TCB board, TB2, pins 1 and 2.

The unit will now start when the external switch is closed and stop when the switch is opened.

Note: If the integral overload protection is not used (see JP-1 Motor Protection Jumper, in Sec. 2.2.3), then bi-metallic overload protection is required (customer supplied if factory emergency overload protection option has not been included.)



DANGER

HAZARDOUS OPERATION
Do not operate the Bypass Contactor with medium voltage power applied to the unit.
Failure to follow this instruction will cause the motor to start unexpectedly.

Chapter 4 - User Interface & Menu Navigation

This chapter explains the keypad operator interface, the LCD descriptions and the programming features.

4.1 Keypad/Operator Interface

The user keypad/ operator interface consists of:

- 2 row by 20 characters Liquid Crystal Display (LCD)
- 12 LEDs
- 8 pushbuttons

Note: The soft starter is menu driven and there are three levels of programming. The programming for two of these levels is password protected. Level two requires a three digit password and level three requires a four digit password.

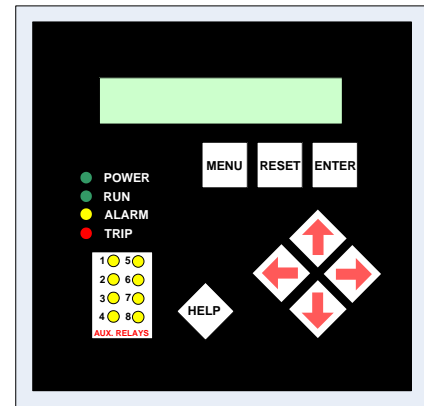

4.1.1. Keypad Operator designations and functions

ITEM	DESIGNATION	DESCRIPTION
KEY	MENU	Toggle between the menu selection for metering and set point pages.
	RESET	Will clear the trip indicator and release the trip relay.
	ENTER	Pressing the ENTER button once enters the EDIT mode where set point values can be changed. An "Asterisk" will appear on the display to indicate it is in the edit mode. After a set point value is changed, pressing the ENTER button again will save the revised value to memory and the asterisk will go off indicating the change has been saved. When not in the edit mode, the ENTER pushbutton will toggle through the event indicator list (such as alarms or trips)
	HELP	Provides general help information about a specific set point or action.
	UP ARROW	Will scroll up through the set point and metering menu page. It will scroll to the top of the set point page or a section. In edit mode it will increase a set point in an incremental step or toggle through the available options in the set point.
	RIGHT ARROW	In the main menu the RIGHT ARROW button provides access to the set point page. For set point pages with multiple columns, the RIGHT ARROW will scroll the set point page to the right. When in edit mode it will shift one character to the right.
	DOWN ARROW	Will scroll down through the set point pages and down through the set points. In edit mode, it will decrement through values and toggle available options in the set point.
	LEFT ARROW	Will move to the left through set point pages with multiple columns. When in edit mode it will become the backspace key and will shift one character to the left.
LED	POWER	Indicates control power is present
	RUN	Indicates unit/motor is running
	ALARM	Lights in conjunction with Relay AUX 2 to indicate an Alarm event or warn of possible critical condition.
	TRIP	Lights in conjunction with Relay AUX 1 to indicate a Trip condition has occurred.
	AUX 1- 8	Auxiliary relays (Note: Relays 5-8 are available for customer use)

Note: The directional arrow buttons require careful operation. In edit mode, if the buttons are held for a long period, the scrolling speed will increase.

4.2 Menu Navigation

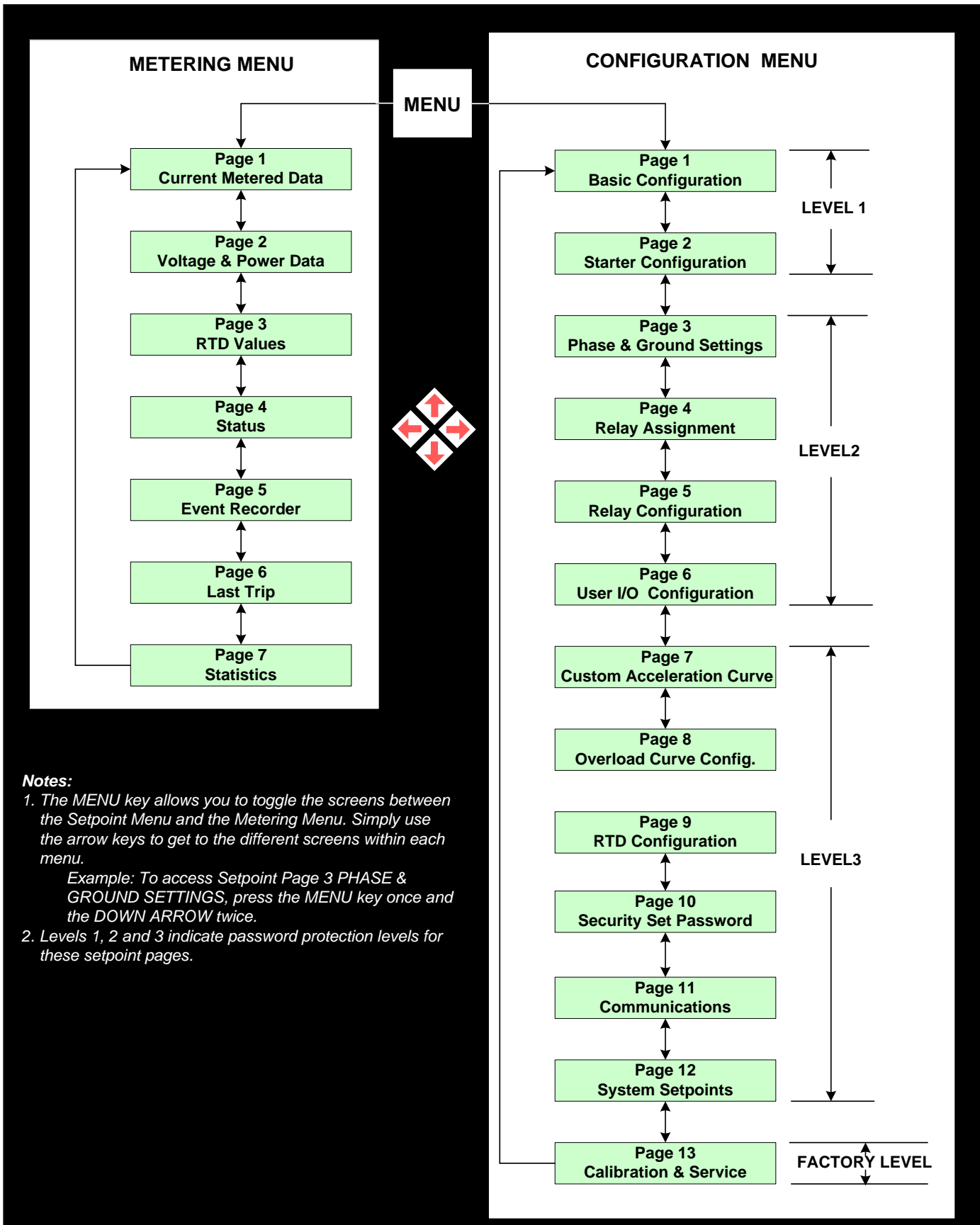

4.2.1 Password Access

Screens in Level 1 of the set point menu can be changed without password access because they list basic motor information. Screens in Levels 2 and 3 require passwords because they provide more in-depth protection and control of the unit. The password in Levels 2 and 3 can be changed by the user.

Note: Set Points can only be changed when the motor is in Stop/ Ready Mode! The soft starter will not allow a start if it is still in the Edit Mode. When the unit is in the Edit Mode, an asterisk is displayed in the top right corner screen.

4.2.2 Changing Set Points

Example 1: Changing Motor FLA from 140 AMPS to 142 AMPS

1. Press MENU button to display Set point Page 1, Basic Configuration
2. Press the RIGHT ARROW you will view the screen Motor Full Load Amps.
3. Press the ENTER button for edit mode. **Note:** The asterisk (*) in the top right corner of the LCD screen that indicates Edit Mode.
4. To change the value, select the UP ARROW or DOWN ARROW. In this case push the UP ARROW twice (2x).
5. To accept the new value, press the ENTER button. The unit will accept the changes and will leave the edit mode. Note the * is no longer in the top right corner of the LCD Display.

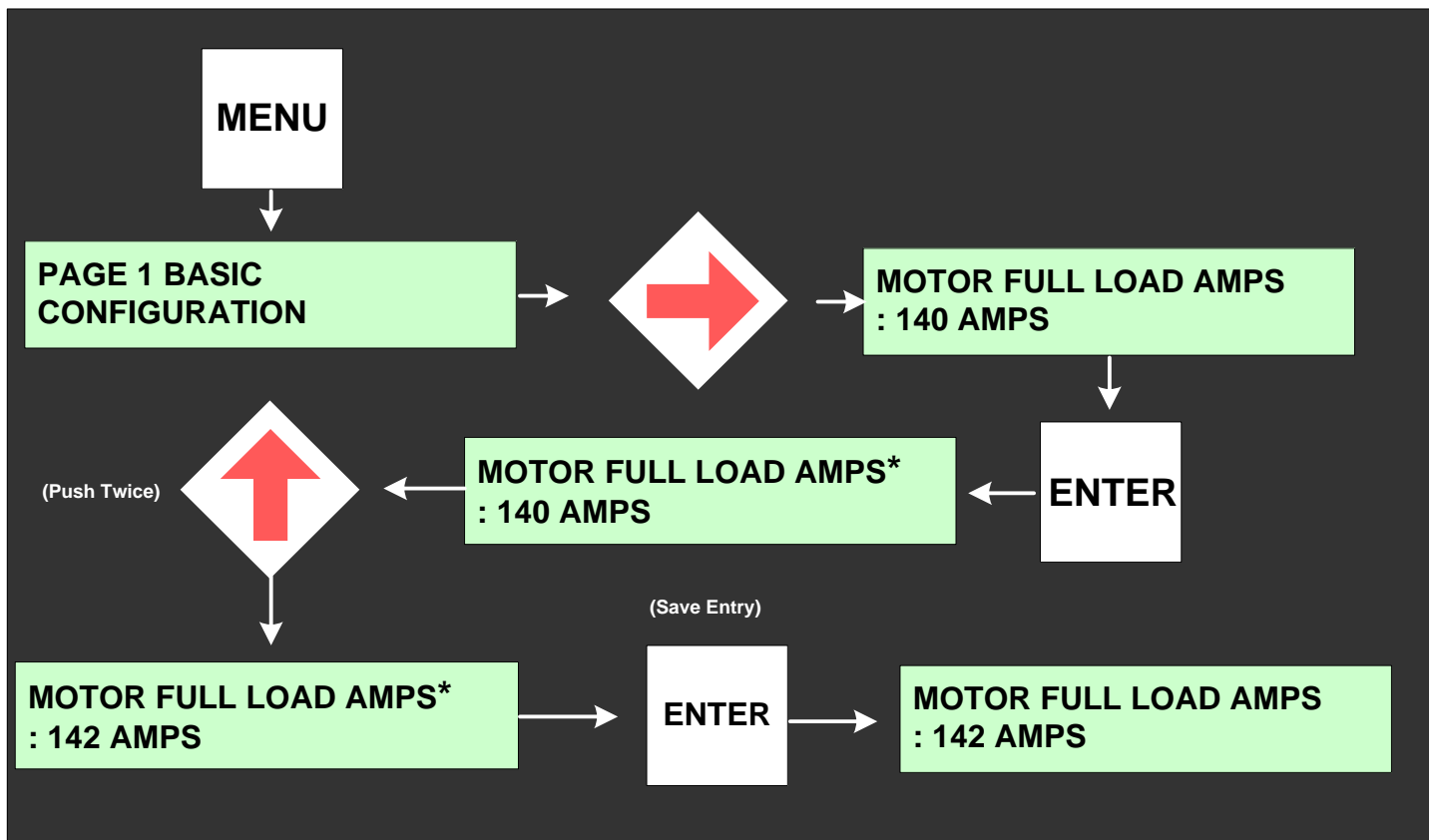

Chapter 5 - Setpoint Programming

The soft starter has thirteen programmable Setpoint pages which define the motor data, ramp curves, protection, I/O configuration and communications. In Section 5.1, the Setpoint pages are outlined in chart form. In Section 5.2 the Setpoint pages are illustrated and defined for easy navigation and programming. **Note:** Setpoints can only be changed when the starter is in the Ready Mode. Also the soft start will not start when it is in programming mode.

5.1 Setpoints Page List

These charts list the Setpoint Page, the programmable functions and the section.

5.1.1 Basic Configuration (Setpoint Page1)

Setpoint Page	Security Level	Description	Factory Setting Default	Range	Section
Page 1 Basic Configuration	Level 1 No Password Required	Motor Full Load Amps (FLA)	Model dependent	50 - 100% of Unit Max Current Rating (Model and Service Factor dependent)	SP1.1
		Motor Full Load Amps (FLA) 2ND	Model dependent		
		Service Factor	1.15	1.00 – 1.3	SP1.2
		Overload Class	10	O/L Class 5-30	SP1.3
		NEMA Design	B	A-F	SP1.4
		Insulation Class	F	A, B, C, E, F, H, K, N, S	SP1.5
		Line Voltage	Model dependent	100 to 20000V	SP1.6
		Line Frequency	60	50 or 60 HZ	SP1.7

5.1.2 Starter Configuration (Setpoint Page 2)

Setpoint Page	Security Level	Description	Factory Setting Default	Range	Section
Page 2 Starter Configuration	Level 1 No Password Required	Start Control Mode	Start Ramp 1	Jog, Start Ramp 1, Start Ramp 2, Custom Accel Curve, Start Disabled, Dual Ramp, Tach Ramp	SP2.1
		Jog Voltage	30%	5-75%, Off	SP2.2
		Start Ramp #1 Type	Voltage	Voltage, Current	SP2.3
		Initial Voltage #1	20%	0-100%	
		Ramp Time #1	10 sec	1-120 sec	
		Current Limit #1	350% FLA	200-500 %	
		Initial Current #1	200% FLA	0-300 %	
		Ramp Time #1	10 sec	1-120 sec	
		Maximum Current #1	350% FLA	200-500 %	SP2.4
		Start Ramp #2 Type	Disabled	Disabled, Voltage, Power	
		Initial Voltage #2	60%	0-100 %	
		Ramp Time #2	10 sec	1-120 sec	
		Current Limit #2	350% FLA	200-500 %	
		Initial Power #2	20%	0-100 %	
		Ramp Time #2	10 sec	1-120 sec	SP2.5
		Maximum Power #2	80%	0 – 300 %	
		Kick Start Type	Disabled	Voltage or Disabled	
		Kick Start Voltage	65%	10-100 %	
		Kick Start Time	0.50 sec	0.10-2.00	SP2.6
		Deceleration	Disabled	Enabled or Disabled	
Start Deceleration Voltage	100%	10-100 %			
Stop Deceleration Voltage	30%	0-100 %			
Deceleration Time	5 sec	1-60 sec	SP2.7		
Timed Output Time	Off	1-1000 sec, Off			
Run Delay Time	1 Sec	1-30 sec, Off	SP2.8		
At Speed Delay Time	1 Sec	1-30 sec, Off	SP2.9		
Bypass Pull-in Current	100% FLA	90 – 300%	SP2.10		

5.1.3 Phase and Ground Settings (Setpoint Page 3)

Setpoint Page	Security Level	Description	Factory Setting Default	Range	Section
Page 3 Phase and Ground Settings	Level 2 Password Protected	Imbalance Alarm Level	15% FLA	5-30 %, Off	SP3.1
		Imbalance Alarm Delay	1.5 sec	1.0-20.0 sec	
		Imbalance Trip Level	20%	5-30 %, Off	SP3.2
		Imbalance Trip Delay	2.0 sec	1.0-20.0 sec	
		Undercurrent Alarm Level	Off	10-90 %, Off	SP3.3
		Undercurrent Alarm Delay	2.0 sec	1.0-60.0 sec	
		Overcurrent Alarm Level	Off	100-300 %, Off	SP3.4
		Overcurrent Alarm Delay	2.0 sec	1.0-20.0 sec	
		Overcurrent Trip Level	Off	100-300 %, Off	SP3.5
		Overcurrent Trip Delay	2.0 sec	1.0-20.0 sec	
		Phase Loss Trip	Enabled	Enabled or Disabled	SP3.6
		Phase Loss Trip Delay	0.1 sec	0-20.0 sec	
		Phase Rotation Detection	ABC	ABC, ACB or Disabled	SP3.7
		Phase Rotation Trip Delay	1.0 sec	1.0 - 20.0 sec	
		*Ground Fault Alarm Level	Off	5-90 %, Off	SP3.8
		*Ground Fault Alarm Delay	0.1 sec	0.1-20.0 sec	
		*Ground Fault Loset Trip Level	Off	5-90 %, Off	SP3.9
		*Ground Fault Loset Trip Delay	20.0 sec	0.1-20 sec	
		*Ground Fault Hiset Trip Level	Off	5-90 %, Off	SP3.10
		*Ground Fault Hiset Trip Delay	0.250 sec	0.008-0.250 sec	
		Overvoltage Alarm Level	Off	5 -30%, Off	SP3.11
		Overvoltage Alarm Delay	1.0 sec	1.0-30.0 sec	
		Overvoltage Trip Level	10%	5-30%, Off	SP3.12
		Overvoltage Trip Delay	2.0 sec	1.0-30.0 sec	
		Undervoltage Alarm Level	Off	5-30%, Off	SP3.13
		Undervoltage Alarm Delay	1.0 sec	1.0-30.0 sec	
		Undervoltage Trip Level	15%	5-30%, Off	SP3.14
		Undervoltage Trip Delay	2.0 sec	1.0-30.0 sec	
		Line Frequency Trip Window	Disabled	0-6 Hz, Disabled	SP3.15
		Line Frequency Trip Delay	1.0 sec	1.0-20.0 sec	
		P/F Lead P/F Alarm	Off	0.1-1.00, Off	SP3.16
		P/F Lead Alarm Delay	1.0 sec	1-120 sec	
P/F Lead P/F Trip	Off	.01-1.00, Off	SP3.17		
P/F Lead Trip Delay	1.0 sec	1-120 sec			
P/F Lag P/F Alarm	Off	.01-1.00, Off	SP3.18		
P/F Lag Alarm Delay	1.0 sec	1-120 sec			
P/F Lag P/F Trip	Off	.01-1.00, Off	SP3.19		
P/F Lag Trip Delay	1.0 sec	1-120 sec			
Power Demand Period	10 min	1 - 60 min	SP3.20		
KW Demand Alarm Pickup	Off KW	Off, 1-100000			
KVA Demand Alarm Pickup	Off KVA	Off, 1-100000			
KVAR Demand Alarm Pickup	Off KVAR	Off, 1-100000			
Amps Demand Alarm Pickup	Off Amps	Off, 1-100000			

* Ground fault option must be installed

5.1.4 Relay Assignments (Setpoint Page 4)

Setpoint Page	Security Level	Description	Factory Setting			Range	Section
			1st	2nd	3rd		
Page 4 Relay Assignments	Level 2 Password Protected	O/L Trip	Trip Only	None	None	None Trip(AUX1) / Trip Only Alarm(AUX2) AUX3 AUX4 AUX5 - 8 Only Available in 8 Relay System Notes: AUX1 to AUX4 are for Factory use only Do not change! Only AUX 5 - 8 are used in the 2nd & 3rd relay assignments.	SP4.1
		I/B Trip	Trip	None	None		
		S/C Trip	Trip Only	None	None		
		Overcurrent Trip	Trip	None	None		
		Stator RTD Trip	None	None	None		
		Non Stator RTD Trip	None	None	None		
		*G/F Hi Set Trip	Trip	None	None		
		*G/F Lo Set Trip	Trip	None	None		
		Phase Loss Trip	Trip	None	None		
		Accel. Time Trip	Trip Only	None	None		
		Start Curve Trip	Trip Only	None	None		
		Over Frequency Trip	Trip	None	None		
		Under Frequency Trip	Trip	None	None		
		I*I*T Start Curve	Trip	None	None		
		Learned Start Curve	Trip	None	None		
		Phase Reversal	Trip	None	None		
		Overvoltage Trip	Trip	None	None		
		Undervoltage Trip	Trip	None	None		
		Power Factor Trip	None	None	None		
		Tach Accel Trip	None	None	None		
		Inhibits Trip	Alarm	None	None		
		Shunt Trip	Trip Only	None	None		
		Bypass Discrepancy	Trip Only	None	None		
		Low Control Voltage	Trip Only	None	None		
		TCB Fault /ESTOP	Trip	None	None		
		Two Speed	None	None	None		
		Dual Ramp	None	None	None		
		Thermostat	Trip	None	None		
		O/L Warning	Alarm	None	None		
		Overcurrent Alarm	Alarm	None	None		
		SCR Fail Shunt Alarm	None	None	None		
		*Ground Fault Alarm	Alarm	None	None		
		Under Current	None	None	None		
		Motor Running	AUX3	None	None		
I/B Alarm	Alarm	None	None				
Stator RTD Alarm	None	None	None				
Non-Stator RTD Alarm	None	None	None				
RTD Failure Alarm	None	None	None				
Self Test Fail	Trip	None	None				
Thermal Register	Alarm	None	None				
U/V Alarm	Alarm	None	None				
O/V Alarm	Alarm	None	None				
Power Factor Alarm	None	None	None				
KW Demand Alarm	None	None	None				
KVA Demand Alarm	None	None	None				
KVAR Demand Alarm	None	None	None				
Amps Demand Alarm	None	None	None				
Timed Output	None	None	None				
Run Delay Time	None	None	None				
At Speed	AUX4	None	None				

* Ground fault option must be installed

5.1.5 Relay Configuration (Setpoint Page 5)

Setpoint Page	Security Level	Description	Factory Setting Default	Range	Section
Page 5 Relay Configuration	Level 2 Password Protected	Trip (AUX1) Fail-Safe	No	Yes or No	SP5.1
		Trip (AUX1) Relay Latched	Yes		SP5.2
		Alarm (AUX2) Fail-Safe	No		SP5.1
		Alarm (AUX2) Relay Latched	No		SP5.2
		AUX3 Relay Fail-Safe	No		SP5.1
		AUX3 Relay Latched	No		SP5.2
		AUX4 Relay Fail-Safe	No		SP5.1
		AUX4 Relay Latched	No		SP5.2
		AUX5 Relay Fail-Safe	No		SP5.1
		AUX5 Relay Latched	No		SP5.2
		AUX6 Relay Fail-Safe	No		SP5.1
		AUX6 Relay Latched	No		SP5.2
		AUX7 Relay Fail-Safe	No		SP5.1
		AUX7 Relay Latched	No		SP5.2
		AUX8 Relay Fail-Safe	No		SP5.1
AUX8 Relay Latched	No	SP5.2			

5.1.6 User I/O Configuration (Setpoint Page 6)

Setpoint Page	Security Level	Description	Factory Setting Default	Range	Section
Page 6 User I/O Configuration	Level 2 Password Protected	Tachometer Scale Selection	Disabled	Enabled or Disabled	SP6.1
		Manual Tach Scale 4.0 mA:	0 RPM	0 - 3600	
		Manual Tach Scale 20.0 mA:	2000 RPM	0 - 3600	
		Tach Accel Trip Mode Select	Disabled	Underspeed, Overspeed or Disabled	SP6.2
		Tach Ramp Time	20 sec	1 - 120	
		Tach Underspeed Trip PT	1650 RPM	0 - 3600	
		Tach Overspeed Trip PT	1850 RPM	0 - 3600	
		Tach Accel Trip Delay	1 sec	1 - 60	SP6.3
		Analog Output #1	RMS Current	Off, RPM 0-3600, Hottest Non-Stator RTD 0-200°C, Hottest Stator RTD 0 - 200°C, RMS Current 0 - 7500 A, % Motor Load 0 - 600% Kw	
		Analog Output #1 4mA:	0	0-65535	
		Analog Output #1 20mA:	250	0-65535	SP6.4
		Analog Output #2	% Motor Load	Same As Analog Input #1	
		Analog Output #2 4mA:	0	0-65535	
		Analog Output #2 20mA:	1000	0-65535	SP6.5
		User Programmable Ext. Inputs			
		TCB Fault/ESTOP	Enabled	Enabled or Disabled	
		Name Ext. Input #1	<User Defined>	User Defined, up to 15 Characters	
		TCB Fault/ESTOP Type	NO	Normally Open or Closed	
		TCB Fault/ESTOP Time Delay	1 sec	0-60 sec	
		Two Speed	Two Speed	Enabled, Disabled or Two Speed	
		Name Ext. Input #2	<User Defined>	User Defined, up to 15 Characters	
		Two Speed Type	NO	Normally Open or Closed	
		Two Speed Time Delay	0 sec	0-60 sec	
		Dual Ramp, Input #3	Dual Ramp	Enabled, Disabled or Dual Ramp	
		Name Ext. Input #3	<User Defined>	User Defined, up to 15 Characters	
		Dual Ramp Type	NO	Normally Open or Closed	
		Dual Ramp Time Delay	0 sec	0-60 sec	
Thermostat	Thermostat	Enabled, Disabled or Thermostat			
Name Ext. Input #4	<User Defined>	User Defined, up to 15 Characters			
Thermostat Type	NC	Normally Open or Closed			
Thermostat Time Delay	0 sec	0-60 sec			

5.1.7 Custom Acceleration Curve (Setpoint Page 7)

Setpoint Page	Security Level	Description	Factory Setting Default	Range	Section
Page 7 Custom Acceleration Curve	Level 3 Password Protected	Custom Accel Curve	Disabled	Disabled, Curve A, B, or C	SP7.1
		Custom Curve A			
		Curve A Voltage Level 1	25%	0-100%	
		Curve A Ramp Time 1	2 sec	1-60 sec	
		Curve A Voltage Level 2	30%	0-100%	
		Curve A Ramp Time 2	2 sec	1-60 sec	
		Curve A Voltage Level 3	37%	0-100%	
		Curve A Ramp Time 3	2 sec	1-60 sec	
		Curve A Voltage Level 4	45%	0-100%	
		Curve A Ramp Time 4	2 sec	1-60 sec	
		Curve A Voltage Level 5	55%	0-100%	
		Curve A Ramp Time 5	2 sec	1-60 sec	
		Curve A Voltage Level 6	67%	0-100%	
		Curve A Ramp Time 6	2 sec	1-60 sec	
		Curve A Voltage Level 7	82%	0-100%	
		Curve A Ramp Time 7	2 sec	1-60 sec	
		Curve A Voltage Level 8	100%	0-100%	
		Curve A Ramp Time 8	2 sec	1-60 sec	
		Curve A Current Limit	350% FLA	200-500%	
		Custom Curve B		Same Programmable Data Points and Ranges as Custom Curve A	
Custom Curve C		Same Programmable Data Points and Ranges as Custom Curve A			

5.1.8 Overload Curve Configuration (Setpoint Page 8)

Setpoint Page	Security Level	Description	Factory Setting Default	Range	Section
Page 8 Overload Curve Configuration	Level 3 Password Protected	Basic Run Overload Curve			SP8.1
		Run Curve Locked Rotor Time	O/L Class	1-30 sec, O/L Class	
		Run Locked Rotor Current	600% FLA	400-800%	
		Coast Down Timer	Disabled	1-60 Min, Disabled	
		Basic Start Overload Curve			SP8.2
		Start Curve Locked Rotor Time	O/L Class	1-30 sec, O/L Class	
		Start Locked Rotor Current	600% FLA	400-800%	
		Acceleration Time Limit	30 sec	1-300 sec, Disabled	
		Number of Starts Per Hour	Disabled	1-6, Disabled	
		Time Between Starts Time	5 min	1-60 Min, Disabled	
		Area Under Curve Protection	Disabled	Enabled or Disabled	SP8.3
		Max I*I*T Start	368 FLA	1-2500 FLA*FLA*sec	SP8.4
		Current Over Curve	Disabled	Disabled, Learn, Enabled	
		Learned Start Curve Bias	10%	5-40%	
		Time for Sampling	30 sec	1-300 sec	

5.1.9 RTD Option Configuration (Setpoint Page 9)

Setpoint Page	Security Level	Description	Factory Setting Default	Range	Section
Page 9 RTD Configuration	Level 3 Password Protected	Use NEMA Temp for RTD Values	Disabled	Enabled or Disabled	SP9.1
		# of RTD Used for Stator	6	0-6	SP9.2
		RTD Voting	Disabled	Enabled or Disabled	SP9.3
		Stator Phase A1 Type	Off	120 OHM NI, 100 OHM NI, 100 OHM PT, 10 OHM CU	SP9.4
		RTD #1 Description	STATOR PHAS A1	User defined, Up to 15 Characters	
		Stator Phase A1 Alarm Level	Off	0-240C (32-464F), Off	
		Stator Phase A1 Trip Level	Off	0-240C (32-464F), Off	
		Stator Phase A2 Type	Off	Same as Stator Phase A1	
		RTD #2 Description	STATOR PHAS A2	User defined, Up to 15 Characters	
		Stator Phase A2 Alarm Level	Off	0-240C (32-464F), Off	
		Stator Phase A2 Trip Level	Off	0-240C (32-464F), Off	
		Stator Phase B1 Type	Off	Same as Stator Phase A1	
		RTD #3 Description	STATOR PHAS B1	User defined, Up to 15 Characters	
		Stator Phase B1 Alarm Level	Off	0-240C (32-464F), Off	
		Stator Phase B1 Trip Level	Off	0-240C (32-464F), Off	
		Stator Phase B2 Type	Off	Same as Stator Phase A1	
		RTD #4 Description	STATOR PHAS B2	User defined, Up to 15 Characters	
		Stator Phase B2 Alarm Level	Off	0-240C (32-464F), Off	
		Stator Phase B2 Trip Level	Off	0-240C (32-464F), Off	
		Stator Phase C1 Type	Off	Same as Stator Phase A1	
		RTD #5 Description	STATOR PHAS C1	User defined, Up to 15 Characters	
		Stator Phase C1 Alarm Level	Off	0-240C (32-464F), Off	
		Stator Phase C1 Trip Level	Off	0-240C (32-464F), Off	
		Stator Phase C2 Type	Off	Same as Stator Phase A1	
		RTD #6 Description	STATOR PHAS C2	User defined, Up to 15 Characters	
		Stator Phase C2 Alarm Level	Off	0-240C (32-464F), Off	
		Stator Phase C2 Trip Level	Off	0-240C (32-464F), Off	
		End Bearing Type	Off	Same as Stator A1	
		RTD #7 Description	END BEARING	User defined, Up to 15 Characters	
		End Bearing Alarm Level	Off	0-240C (32-464F), Off	
		End Bearing Trip Level	Off	0-240C (32-464F), Off	
		Shaft Bearing Type	Off	Same as Stator Phase A1	
		RTD #8 Description	SHAFT BEARING	User defined, Up to 15 Characters	
		Shaft Bearing Alarm Level	Off	0-240C (32-464F), Off	
		Shaft Bearing Trip Level	Off	0-240C (32-464F), Off	
		RTD #9 Type	Off	Same as Stator Phase A1	
		RTD #9 Description	<User defined >	User defined, Up to 15 Characters	
		RTD #9 Alarm Level	Off	0-240C (32-464F), Off	
		RTD #9 Trip Level	Off	0-240C (32-464F), Off	
		RTD #10 Type	Off	Same as Stator Phase A1	
		RTD #10 Description	<User defined >	User defined, Up to 15 Characters	
RTD #10 Alarm Level	Off	0-240C (32-464F), Off			
RTD #10 Trip Level	Off	0-240C (32-464F), Off			
RTD #11 Type	Off	Same as Stator Phase A1			
RTD #11 Description	<User defined >	User defined, Up to 15 Characters			
RTD #11 Alarm Level	Off	0-240C (32-464F), Off			
RTD #11 Trip Level	Off	0-240C (32-464F), Off			
RTD #12 Type	Off	Same as Stator Phase A1			
RTD #12 Description	<User defined >	User defined, Up to 15 Characters			
RTD #12 Alarm Level	Off	0-240C (32-464F), Off			
RTD #12 Trip Level	Off	0-240C (32-464F), Off			
RTD Trip Delay	10 sec	1 – 60 sec			
RTD Alarm Delay	5 sec	1 – 60 sec			

5.1.10 Password Level Configuration (Setpoint Page10)

Setpoint Page	Security Level	Description	Factory Setting Default	Range	Section
Page 10 Password	Level 3 Password	Set Level 2 Password	100	000 – 999 Three Digits	SP10.1
		Set Level 3 Password	1000	0000 – 9999 Four Digits	SP10.2

5.1.11 Communications Configuration (Setpoint Page11)

Setpoint Page	Security Level	Description	Factory Setting Default	Range	Section
Page 11 Communications	Level 3 Password	Set Front Baud Rate	9.6 KB/sec	2.4, 4.8, 9.6, 19.2, 38.4 KB/sec	SP11.1
		Set Modbus Baud Rate	9.6 KB/sec	2.4, 4.8, 9.6, 19.2, 38.4 KB/sec	SP11.2
		Modbus Address Number	247	1 – 247	SP11.3
		Set Access Code	1	1 – 999	SP11.4
		Set Link Baud Rate	38.4 KB/sec	2.4, 4.8, 9.6, 19.2, 38.4 KB/sec	SP11.5
		Remote Start/Stop	Disabled	Enabled or Disabled	SP11.6

5.1.12 System (Setpoint Page 12)

Setpoint Page	Security Level	Description	Factory Setting Default	Range	Section
Page 12 System Setpoints	Level 3 Password Protected	Default Display Screen			SP12.1
		Metering Data Page #	1	Enter Metering Page (1-4)	
		Metering Data Screen #	1	Enter Metering Screen Page 1(1-10) Page 2 (1-11) Page 3 (1 - 29) Page 4 (1 - 6)	
		Alarms			SP12.2
		RTD Failure Alarm	Disabled	Enabled or Disabled	
		Thermal Register Alarm	90%	Off, 40-95%	
		Thermal Alarm Delay	10 sec	1-20 sec	
		Thermal Register Setup Info			SP12.3
		Cold Stall Time	O/L Class	O/L Class (5-30) or 4-40 second time delay	
		Hot Stall Time	½ O/L Class	½ O/L Class, 4-40 sec	
		Stopped Cool Down Time	30 Min	10-300 Min	
		Running Cool Down Time	15 Min	10-300 Min	
		Relay Measured Cool Rates	Disabled	Enabled or Disabled	
		Thermal Register Minimum	15%	10-50%	
		Motor Design Ambient Temp	40C	10-90C	
		Motor Design Run Temperature	80% Max	50-100% of Motor Stator Max Temp	
		Motor Stator Max Temp	INS CLS	INS CLS, 10-240 C	
		I/B Input to Thermal Register	Disabled	Enabled or Disabled	SP12.4
		Use Calculated K or Assign	7	1-50, On	
		Press Enter to Clr Thermal Register			

5.1.13 Calibration and Service (Setpoint Page 13)

Setpoint Page	Security Level	Description	Factory Setting Default	Range	Section
Page 13 Calibration & Service	Factory Use Only	Set Date and Time (DDMMYY:HHMM)	FACTORY SET; ## / ## / ## ## : ##		SP13.1
		Enter Date (DDMMYYYY)	FACTORY SET; ## / ## / #####	D=1-31, M=1-12, Y=1970-2069	
		Enter Time (HH:MM)	FACTORY SET; ## :##	H=00-23, M=0-59	
		Model # Firmware REV. #	FACTORY SET; #####	Display Only, Cannot be changed	SP13.2
		Press Enter to Access Factory Settings		Available to Qualified Factory Personnel	SP13.3

5.2 Setpoints Menu and Parameter Explanation (SP1 – SP13)

SP.1 Basic Configuration (Setpoint Page 1)

In Setpoint Page 1, is used to setup basic nameplate data of the motor.

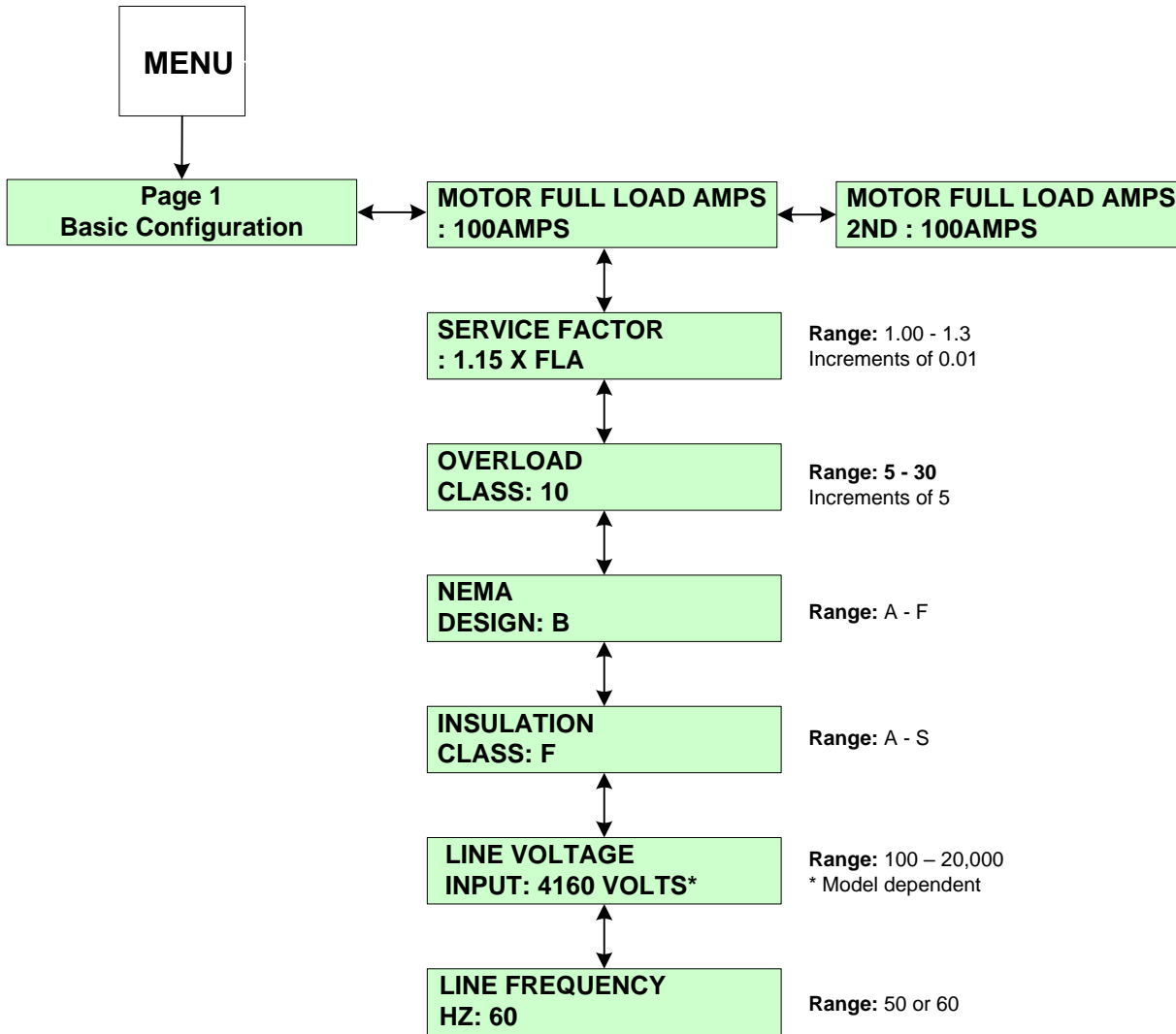

SP1.1 Motor Full Load Amps (FLA): Allows the user to enter the motor's FLA rating. Range of adjustment is 50 - 100% (less programmed service factor).

SP1.2 Service Factor: Sets the pickup point on the overload curve as defined by the programmed motor full load current. Ex: If the motor FLA is 100 and the service factor is 1.15, the overload pickup point will be 115 Amps.

SP1.3 Overload Class: Choose the motor protection overload class, range from 5-30. Ex: Overload Class 10 will trip in 10 seconds at six times Motor FLA.

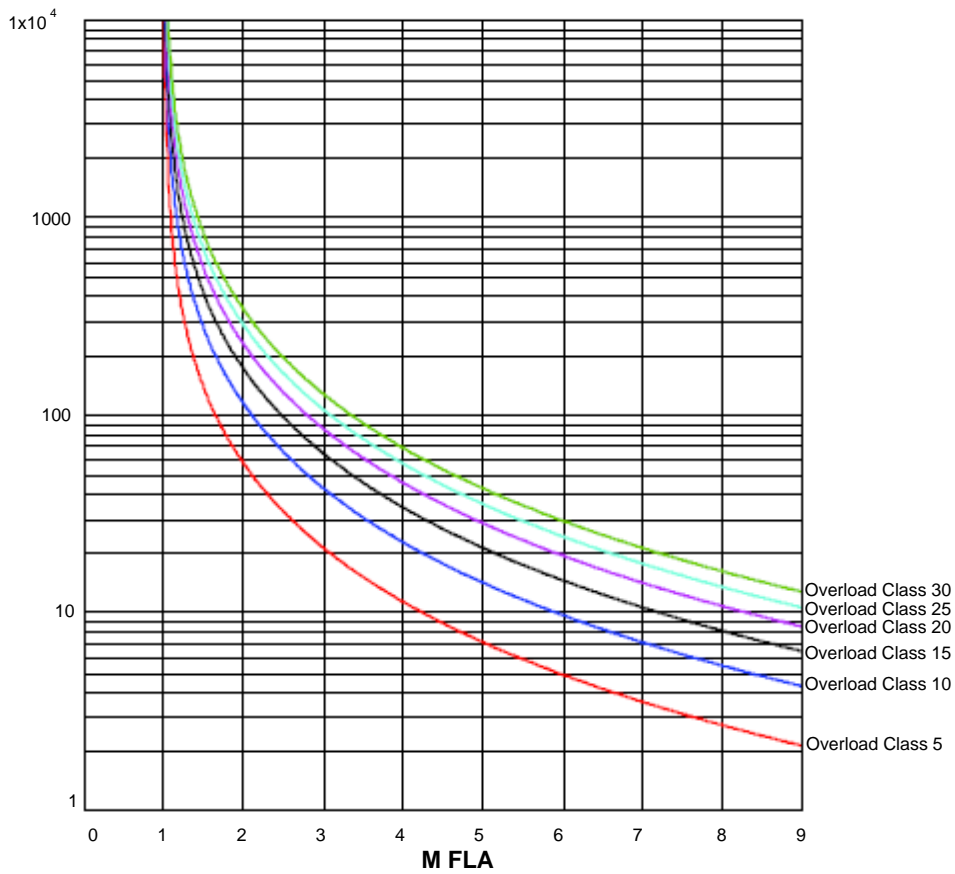

SP1.4 NEMA design: The motor design maximum allowed slip (Select from Class A through F).

SP1.5 Insulation Class: The motor insulation temperature class (Select A, B, C, E, F, G, H, K, N or S).

SP1.6 Line Voltage Input: Applied Voltage.

SP1.7 Line Frequency: The user may choose either 50 Hz or 60 Hz.

SP.2 Starter Configuration (Setpoint Page 2)

Provides multiple choices for starting ramps that can be selected for particular loads and applications.

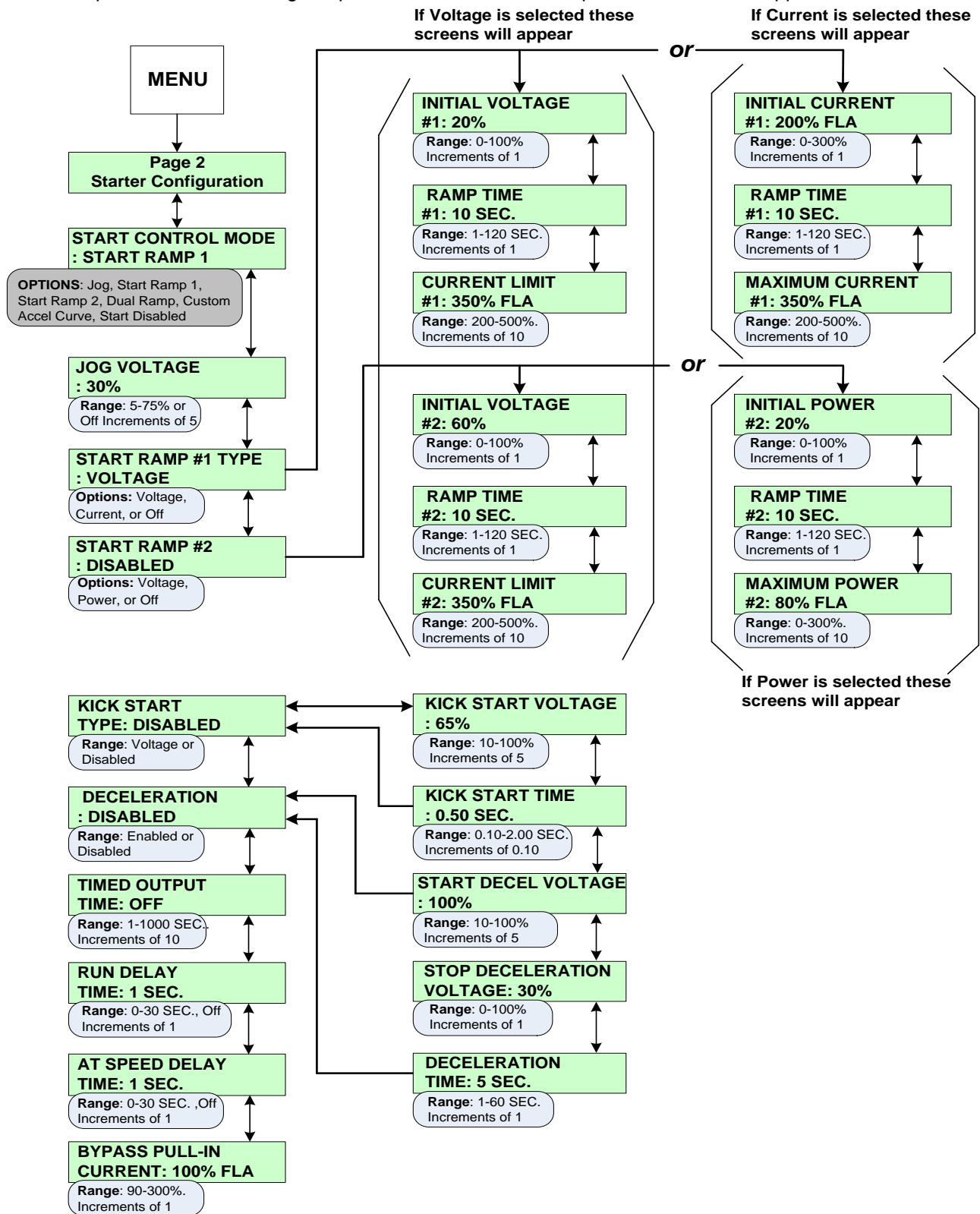

SP2 Starter Configuration (Setpoint Page 2) Menu Navigation

SP2.1 Start Control Mode: Dual Ramp, Custom Accel Curve, Jog Voltage, Start Ramp 1, Start Ramp 2.

- **Dual Ramp:** The dual ramp mode works in conjunction with External Input #3. This allows the user to switch between the two start ramps without having to reconfigure the start mode. (For details on configuring External Input #3 for DUAL RAMP see Setpoint **Page 6**.)

- **Custom Accel Curve:** Allows the user to custom design the acceleration start curve to the application. (See Setpoint page 7 for configuration setup.)

Note: If Custom Accel Curve has not been enabled in Setpoint page 7, the soft starter will ignore the start control mode and read this Setpoint as disabled.

SP2.2 Jog Voltage: The voltage level necessary to cause the motor to slowly rotate.

SP2.3 Start Ramp 1 Type: The ramp type can be setup for either Voltage or Current. If Voltage is selected, initial voltage, ramp time and current limit are adjustable. If Current is selected, initial current, ramp time and maximum current are adjustable.

Start Ramp 1 Type: Voltage

- **Voltage Ramping** is the most reliable starting method, because the starter will eventually reach an output voltage high enough to draw full current and develop full torque. This method is useful for applications where the load conditions change frequently and where different levels of torque are required. Typical applications include material handling conveyors, positive displacement pumps and drum mixers. Voltage is increased from a starting point, (Initial Torque) to full voltage over an adjustable period of time (Ramp Time). To achieve Voltage Ramping, select VOLTAGE for the START RAMP #1 TYPE Setpoint and set CURRENT LIMIT #1 Setpoint to 500% (The maximum setting). Since this is essentially Locked Rotor Current on most motors, there is little or no Current Limit effect on the Ramp profile.

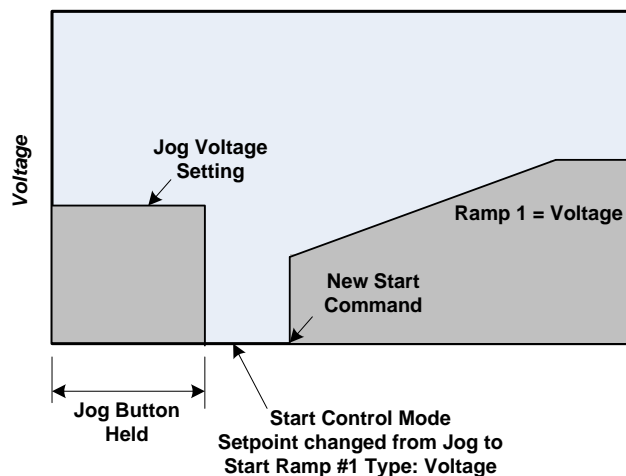

FIG. SP2.3 Example of Switching from Jog to Start Ramp #1 Type: Voltage

- **Voltage Ramping with Current Limit** is the most used curve and is similar to voltage ramping however, it adds an adjustable maximum current output. Voltage is increased gradually until the setting of the Maximum Current Limit Setpoint is reached. The output is held at this level until the motor accelerates to full speed. This may be necessary in applications where the electrical power is limited. Typical applications include portable or emergency generator supplies, utility power near the end of a transmission line and utility starting power demand restrictions.

Note: Using Current Limit will override the Ramp Time setting if necessary, so use this feature when acceleration time is not critical.

To set Voltage Ramping with Current Limit, select VOLTAGE for the START RAMP #1 Setpoint and set CURRENT LIMIT #1 Setpoint to a desired lower setting, as determined by your application requirements.

Start Ramp 1 Type: Current

• **Current Ramping** (Closed Loop Torque Ramping)

This method is used for smooth linear increase of output torque. This ramp is only used on some conveyor systems (long haul or down hill). For other applications, use Voltage Ramp or a custom Accel curve. Output voltage is constantly updated to provide the linear current ramp, and therefore the available torque is maximized at any given speed. This is for applications where rapid changes in torque may result in load damage or equipment changes. Typical applications include overland conveyors if belt stretching occurs; fans and mixers if blade warping is a problem; and material handling systems if stacked products fall over or break.

This feature can be used with or without the Maximum Current Limit setting. To achieve Current Ramping select CURRENT for START RAMP #1 TYPE Setpoint and set the MAXIMUM CURRENT #1 Setpoint to the desired level.

• **Current Limit Only** (Current Step) uses the Current Limit feature exclusively.

This method of starting eliminates the Soft Start voltage/current ramp and instead, maximizes the effective application of motor torque within the limits of the motor. In this mode, Setpoint RAMP TIME #1 is set to minimum so that the output current jumps to the current limit setting immediately. Typically used with a limited power supply when starting a difficult load such as a centrifuge or a deep well pump, when the motor capacity is barely adequate (stall condition or overloading occurs) or if other starting modes fail. Since ramp times are set to minimum, START RAMP #1 TYPE is set to either VOLTAGE or CURRENT.

• **Initial Torque (Initial Voltage #1 or Initial Current #1)**

Sets the initial start point of either Voltage Ramp or the Current Ramp. Every load requires some amount of torque to start from a standstill. It is inefficient to begin ramping the motor from zero every time, since between zero and the WK2 break-away torque level, no work is being performed. The initial torque level should be set to provide enough torque to start rotating the motor shaft, enabling a Soft Start and preventing torque shock damage. Setting this start point too high will not damage the starter, but may reduce or eliminate the soft start effect.

• **Ramp Time #1**

Sets the maximum allowable time for ramping the initial voltage, current (torque) or power setting to either of the following:

- The Current Limit setting when the motor is still accelerating.
- Full output voltage if the Current Limit is set to maximum.
- kW if Power Ramp is selected.

Increasing the ramp time softens the start process by gradually increasing the voltage, current or power. Ideally, the ramp time should be set for the longest amount of time the application will allow (without stalling the motor). Some applications require a short ramp time due to the mechanics of the system. (i.e. centrifugal pumps, because pump problems can occur due to insufficient torque).

• **Current Limit**

Sets the maximum motor current the starter will allow during the acceleration. As the motor begins to ramp, the Current Limit feature sets a maximum at which the current draw is held. Current Limit remains in effect until the following occurs:

- 1) The motor reaches full speed (Detected by the At-Speed detection circuit) or;
- 2) The Overload Protection trips on Motor Thermal Overload. Once the motor reaches full speed, the Current Limit feature becomes inactive. In the Voltage Ramp Profile, the voltage output is increased until it reaches the Current Limit. Ramp time is the maximum amount of time it takes for the voltage to increase until the Current Limit setting takes over. The Current Ramp profile varies the output voltage to provide a linear increase in current up to the Maximum Current Setpoint value. A closed loop feedback of motor current maintains the Current Ramp profile

SP2.4 Start Ramp 2 Type: Please refer to Ramp 1 settings for Ramp 2 Type: Voltage selection.

Start Ramp 2: Power

The **Power Ramp** feature has three programmable set points, Initial Power, Ramp Time and Maximum Power.

- The **Initial Power** set point allows the user to define an initial KW (motor power) value that will be applied to the motor when the start sequence is begun. It has a range of 0-100% and a default value of 20%.
- The **Ramp Time** set point functions as all other ramp time set points and allows the user to define a time period during which the applied KW (motor power) will be increased linearly to the Maximum Power value set point. The adjustment range is 1 to 120 seconds. Once the Power Limit value is reached, the system enters a constant power mode that regulates the applied motor power until the motor reaches full speed.
- The **Maximum Power** set point has an adjustment range of 0-300% and a default value of 80%.

 CAUTION
It is recommended to use the power ramp on a loaded motor! Using the power ramp on an unloaded motor may result in shorter than anticipated acceleration times.

Power Ramp Calculations: The basic motor power value is derived from the line voltage and motor FLA, using a unity power factor as a default. This allows for approximation of the motor power rating without any other input data. During the Power Ramp process, the RMS line voltage, RMS motor current and power factor are measured on a cycle by cycle basis and applied to the Power Ramp algorithm. The CPU then calculates the True RMS motor power and will control the SCR firing to deliver the programmed power ramp values to the motor.

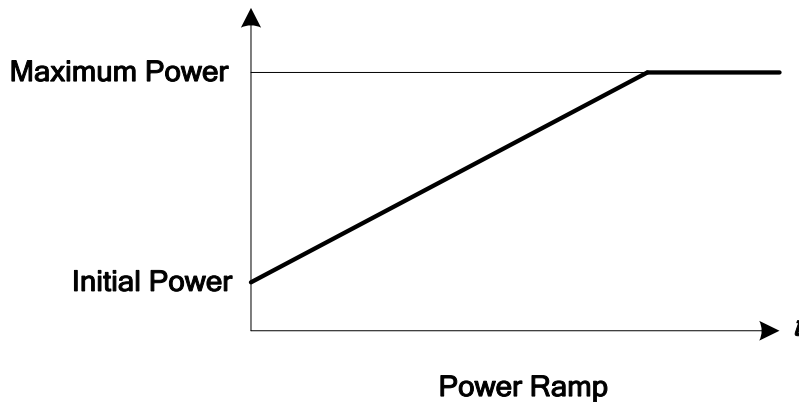

FIG. SP2.4

- **Initial Power:** The Initial power set point allows the user to define an initial KW (motor power) value that will be applied to the motor at the beginning of the start sequence.
- **Ramp Time #2:** See Ramp Time #1 for description
- **Maximum Power:** Sets the maximum motor power the starter will allow during the acceleration. As the motor begins to ramp, the “Maximum Power” sets a limit.

SP2.5 Kick Start: Used as an initial energy burst in applications with high friction loads.

- **Kick Start Voltage:** The initial voltage (as a percent of full voltage value) that is needed to start the motor. (i.e. Breakaway or Initial Torque.)
- **Kick Start Time:** The time the initial torque boost is applied.

SP2.6 Deceleration: Allows the motor to gradually come to a soft stop.

- **Start Deceleration Voltage:** Upon receiving a STOP command the output voltage initially drops to this voltage. (Represented as a percent of voltage value.)
- **Stop Deceleration Voltage:** The drop-off point of the deceleration ramp. (Percent of voltage value.) The point at which the unit output drops to zero to end the deceleration.
- **Deceleration Time:** The time to get to the stop Deceleration Voltage Set point value.

SP2.7 Timed Output: Used with an AUX (5-8) relay. When enabled, and upon a start command, it waits until the programmed time plus the run delayed time has expired. The relay energizes and remains so until a stop command is received. It de-energizes upon receiving a stop command.

SP2.8 Run Delay Time: Can be used with an AUX (5-8) relay. The delay timer begins upon receipt of the start command. The relay will then drop out when the time has expired.

SP2.9 At Speed Delay Time: Used with the AUX 4 relay, it energizes when the motor reaches At Speed and the programmed delay time has expired. The relay remains energized until a stop command has been received.

SP.3 Phase & Ground Settings (Setpoint Page 3) (Security Level 2)

SP3.1 Imbalance Alarm Level: This is an advance warning of a phase imbalance problem. The problem may not be a fault in the motor, but merely caused by imbalanced voltages.

- **Imbalance Alarm Delay:** The amount of time the imbalance condition must exist before an alarm occurs.

SP3.2 Imbalance Trip Level: This will trip the motor on excessive phase imbalance. The trip level should be programmed to a higher value than the alarm level.

- **Imbalance Trip Delay:** The amount of time the imbalance condition must exist before a trip will occur.

SP3.3 Undercurrent Alarm Level: Typically used to warn of possible load loss, a coupling break or other mechanical problems.

- **Undercurrent Alarm Delay:** The amount of time the undercurrent condition must exist before an alarm will occur.

SP3.4 Overcurrent Alarm Level: Typically used to indicate when the motor is overloaded. This feature can be used to either stop the feed to the equipment or warn operators of an overload condition.

- **Overcurrent Alarm Delay:** The amount of time the overcurrent condition must exist before an alarm will occur.

SP3.5 Overcurrent Trip Level: Typically used to indicate the motor is severely overloaded and at which point a trip occurs.

- **Overcurrent Trip Delay:** The amount of time the overcurrent condition must exist before a trip will occur.

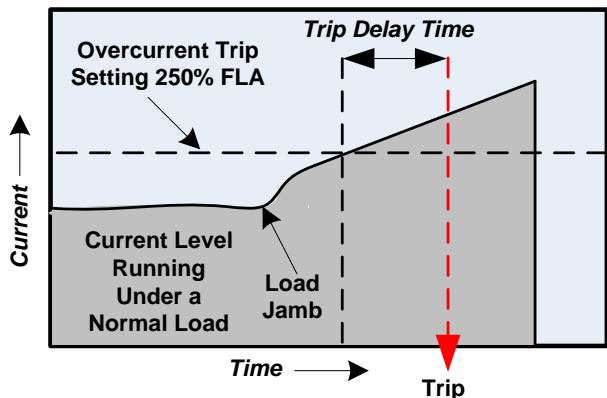
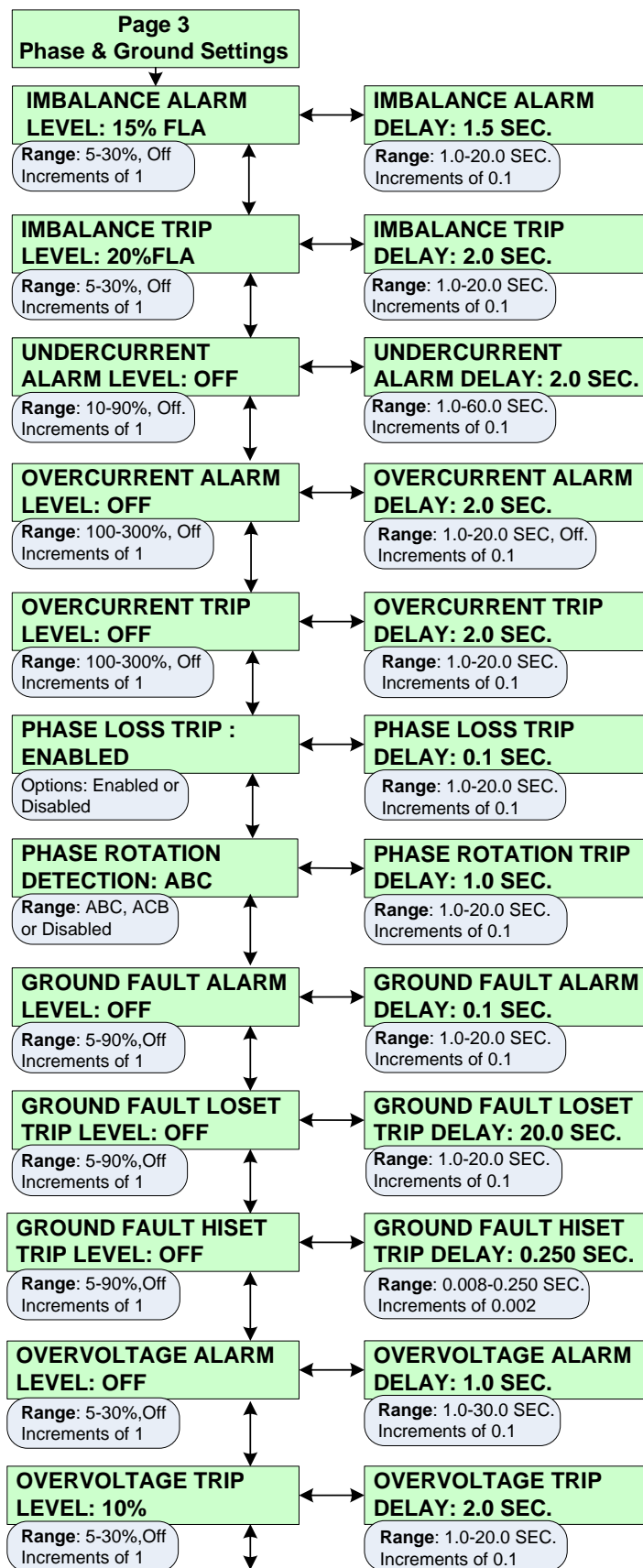

FIG. SP3.5



Continued (Next Page)

SP3.6 Phase Loss Trip: When enabled, the Soft Starter will trip the motor off-line upon a loss of phase power.

- **Phase Loss Trip Delay:** The amount of time the phase loss condition must exist before a trip will occur.

SP3.7 Phase Rotation Detection: The soft starter is continuously monitoring the phase rotation. Upon a start command, a trip will occur if it detects a change in the phase rotation.

- **Phase Rotation:** There are two possible phase rotation options: ABC or ACB. This Setpoint monitors the wiring to ensure that the phase rotation is correct. To view the present phase rotation, go to Metering Page1, screen number 4.

SP3.8 *Ground Fault Alarm: Typically used to warn of low level ground current leakage

- **Ground Fault Alarm Delay:** The amount of time that the ground fault condition must exist before an alarm will occur.

SP3.9 *Ground Fault Loset Trip Level: Typically used to trip the motor on a low level of ground current leakage. This Setpoint is intended to detect high impedance faults.

- **Ground Fault Loset Trip Delay:** The amount of time that the ground fault condition must exist before a trip will occur.

* **Ground Fault Option must be installed**

SP3.10 *Ground Fault Hiset Trip Level: Used to trip the motor (within milliseconds) upon detecting a high level of ground current leakage. This Setpoint is intended to detect low impedance faults.

- ***Ground Fault Hiset Trip Delay:** The amount of time that the ground fault condition must exist before a trip will occur.

SP3.11 Overvoltage Alarm Level: Typically used to indicate when the line voltage is too high. This is an alarm level.

- **Overvoltage Alarm Delay:** The amount of time that the overvoltage condition must exist before an alarm occurs.

Continued (From Previous Page)

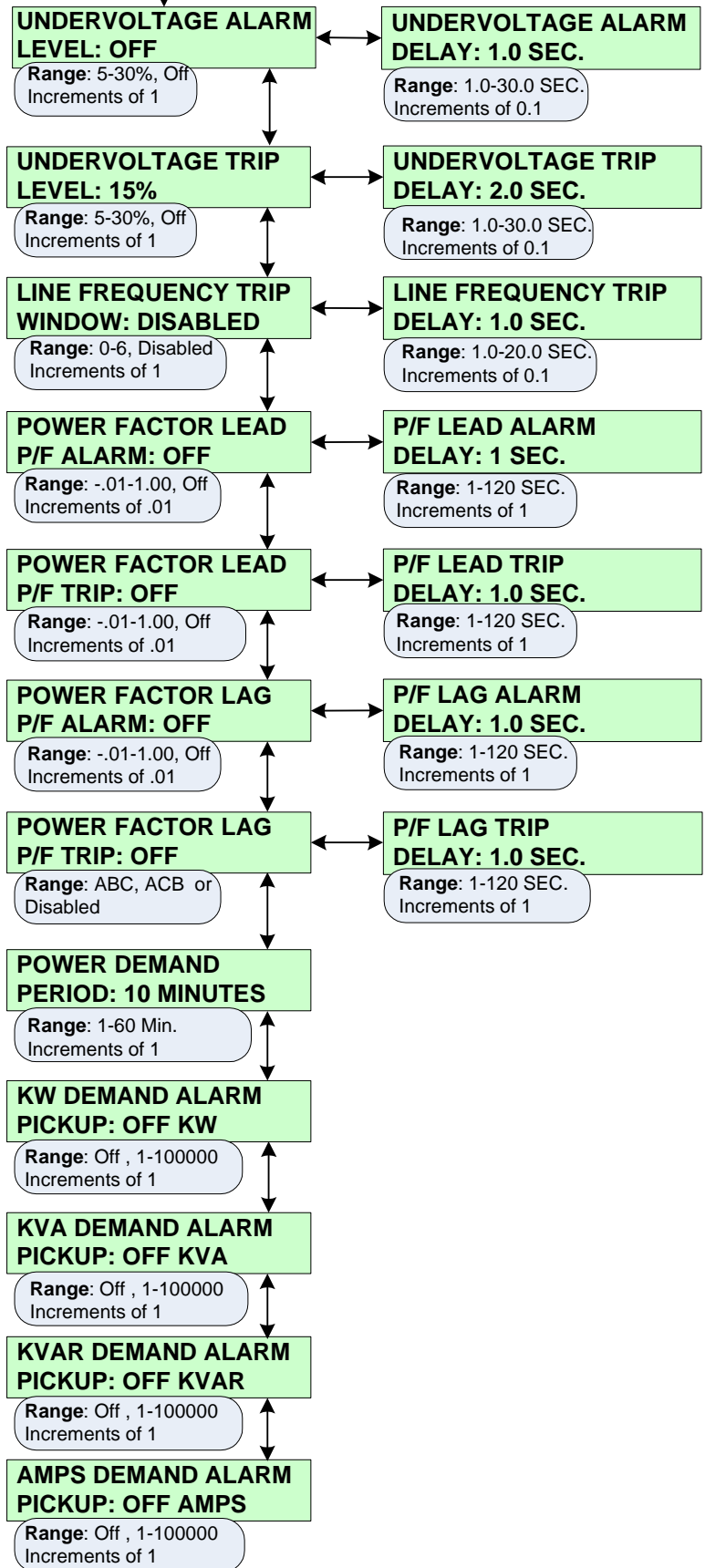

SP3.12 Overvoltage Trip Level: Typically used to indicate that the line voltage is too high and at which point a trip occurs

- **Overvoltage Trip Delay:** The amount of time that the overvoltage condition must exist before a trip will occur.

SP3.13 Undervoltage Alarm Level: Typically used to indicate when the line voltage is too low. This is an alarm level.

- **Undervoltage Alarm Delay:** The amount of time that the undervoltage condition must exist before an alarm occurs.

SP3.14 Undervoltage Trip Level: Typically used to indicate that the line voltage is too low at which point a trip occurs.

- **Undervoltage Trip Delay:** The amount of time that the undervoltage condition must exist before a trip occurs.

SP3.15 Line Frequency Trip Window: The acceptable amount of drift above or below the line frequency (Hz) before a trip is generated.

- **Line Frequency Trip Delay:** The amount of time that the frequency drift condition must exist beyond the window before a trip occurs.

SP3.16 Power Factor Lead Alarm: Typically used to indicate a leading power factor.

- **Power Factor Lead Alarm Delay:** The amount of time that the power factor lead condition must exist beyond the window before an alarm occurs.

SP3.17 Power Factor Lead Trip: The acceptable amount of power factor lead before a trip is generated.

- **Power Factor Lead Trip Delay:** The amount of time that the power factor lead condition must exist beyond the window before a trip will occur.

SP3.18 Power Factor Lag Alarm: Typically used to indicate a lagging power factor.

- **Power Factor Lag Alarm Delay:** The amount of time that the power factor lagging condition must exist beyond the window before an alarm occurs.

SP3.19 Power Factor Lag Trip: The acceptable amount of power factor lag before a trip is generated.

- **Power Factor Lag Trip Delay:** The amount of time that the power factor lag condition must exist beyond the window before a trip will occur.

SP3.20 Power Demand Period: The Soft Starter monitors the demand of the motor based on several parameters (current, kW, kVAR, kVA). Monitoring the demand of the motor assist in the energy management program where processes can be altered or scheduled to reduce overall demand. Demand is calculated by taking samples of the output current, kW, kVAR and kVA over a period of time, then averaged and stored into memory.

SP.4 Relay Assignment (Setpoint Page 4)
(Security Level 2)

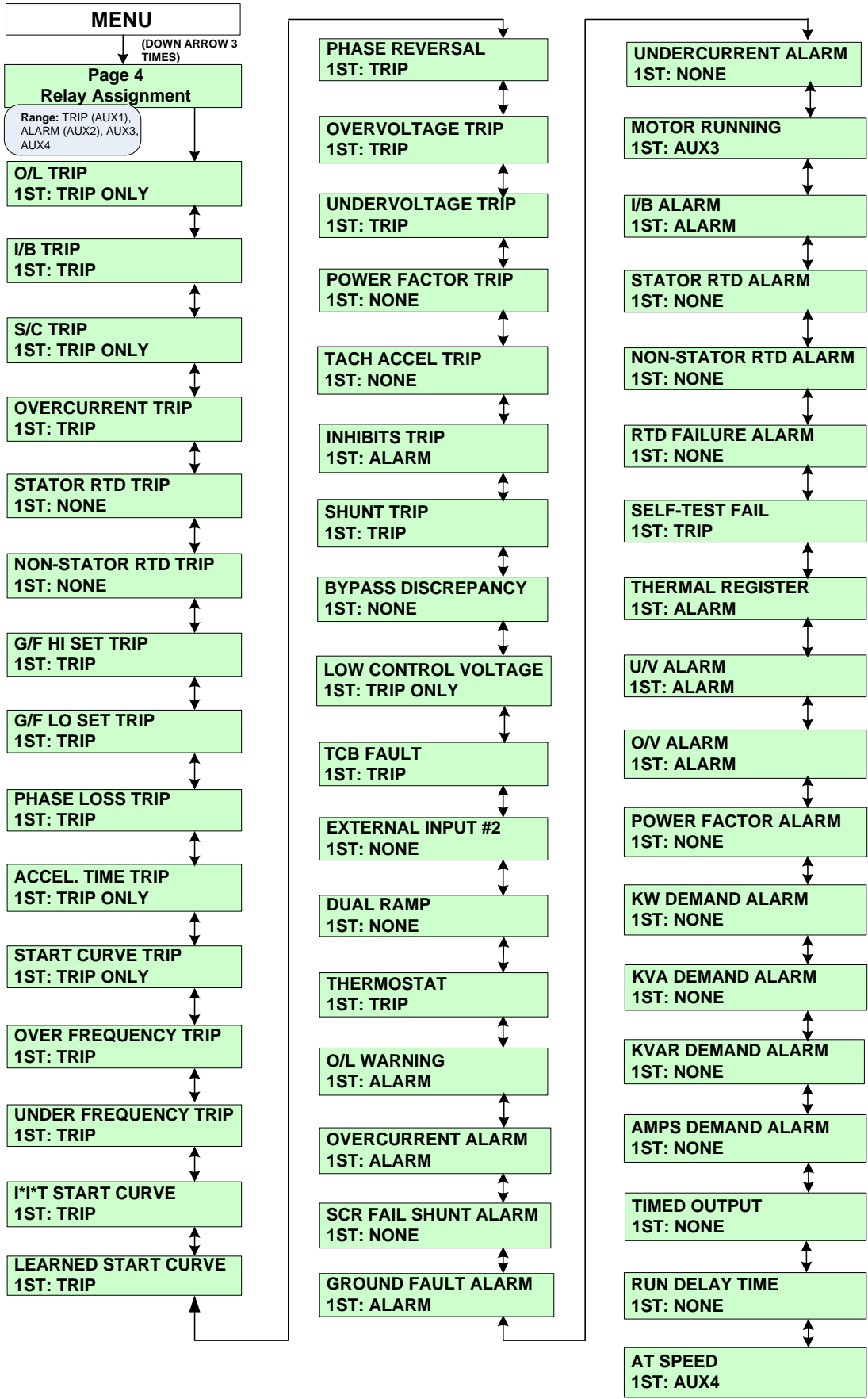

SP.4 Relay Assignment (Setpoint Page 4) – Continued

(Security Level 2)

All of the protective functions of the Soft Starter are user programmable to an output relay. The factory will ship with all tripping functions assigned to TRIP (AUX1) relay, and all alarm functions to ALARM (AUX2) relay.

Note: AUX1 - 4 are Factory Set and should not be changed.

SP4.1 The following is a list of all the user programmable functions.

Note: The 1st Relay Assignments are factory defaults and should not be changed.

RELAY ASSIGNMENTS FUNCTIONS

	<u>1st</u>	<u>2nd</u>	<u>3rd</u>
OVERLOAD TRIP	TRIP ONLY	NONE	NONE
IMBALANCE TRIP	TRIP (AUX1)	NONE	NONE
SHORT CIRCUIT TRIP	TRIP ONLY	NONE	NONE
OVERCURRENT TRIP	TRIP (AUX1)	NONE	NONE
STATOR RTD TRIP	NONE	NONE	NONE
NON-STATOR RTD TRIP	NONE	NONE	NONE
GROUND FAULT HI SET TRIP*	TRIP (AUX1)	NONE	NONE
GROUND FAULT LO SET TRIP*	TRIP (AUX1)	NONE	NONE
PHASE LOSS TRIP	TRIP (AUX1)	NONE	NONE
ACCEL TIME TRIP	TRIP ONLY	NONE	NONE
START CURVE TRIP	TRIP ONLY	NONE	NONE
OVER FREQUENCY TRIP	TRIP (AUX1)	NONE	NONE
UNDER FREQUENCY TRIP	TRIP (AUX1)	NONE	NONE
I ¹ *T START CURVE	TRIP (AUX1)	NONE	NONE
LEARNED START CURVE	TRIP (AUX1)	NONE	NONE
PHASE REVERSAL	TRIP (AUX1)	NONE	NONE
OVERVOLTAGE TRIP	TRIP (AUX1)	NONE	NONE
UNDERVOLTAGE TRIP	TRIP (AUX1)	NONE	NONE
POWER FACTOR TRIP	NONE	NONE	NONE
TACH ACCEL TRIP	NONE	NONE	NONE
INHIBITS TRIP	ALARM (AUX2)	NONE	NONE
SHUNT TRIP	TRIP ONLY	NONE	NONE
BYPASS DISCREPANCY	TRIP ONLY	NONE	NONE
LOW CONTROL VOLTAGE	TRIP ONLY	NONE	NONE
TCB FAULT / ESTOP	TRIP (AUX1)	NONE	NONE
EXTERNAL INPUT 2	NONE	NONE	NONE
DUAL RAMP	NONE	NONE	NONE
THERMOSTAT	TRIP (AUX1)	NONE	NONE
OVERLOAD WARNING	ALARM (AUX2)	NONE	NONE
OVERCURRENT ALARM	ALARM (AUX2)	NONE	NONE
SCR FAIL SHUNT ALARM	ALARM (AUX2)	NONE	NONE
GROUND FAULT ALARM*	ALARM (AUX2)	NONE	NONE
UNDERCURRENT ALARM	NONE	NONE	NONE
MOTOR RUNNING	AUX3	NONE	NONE
IMBALANCE ALARM	ALARM (AUX2)	NONE	NONE
STATOR RTD ALARM	NONE	NONE	NONE
NON-STATOR RTD ALARM	NONE	NONE	NONE
RTD FAILURE ALARM	NONE	NONE	NONE
SELF TEST FAIL	TRIP (AUX1)	NONE	NONE
THERMAL REGISTER	ALARM (AUX2)	NONE	NONE
U/V ALARM	ALARM (AUX2)	NONE	NONE
O/V ALARM	ALARM (AUX2)	NONE	NONE
POWER FACTOR ALARM	NONE	NONE	NONE
KW DEMAND ALARM	NONE	NONE	NONE
KVA DEMAND ALARM	NONE	NONE	NONE
KVAR DEMAND ALARM	NONE	NONE	NONE
AMPS DEMAND ALARM	NONE	NONE	NONE
TIMED OUTPUT	NONE	NONE	NONE
RUN DELAY TIME	NONE	NONE	NONE
AT SPEED	AUX4	NONE	NONE

*Ground fault option must be installed

SP.5 Relay Configuration (Setpoint Page 5) (Security Level 2)

In Setpoint Page 5 the user can configure the four output relays as either fail-safe or non fail-safe and latching or non-latching.

SP5.1 When a relay has been configured for "Fail Safe" and power is applied to the unit the relay will energize and its contacts will change state. The relay will then de-energize and its contacts revert back when an event occurs or if power is removed.

NOTE: The relays in the soft starter will not prevent a start sequence unless they are wired in as interlocks. If power is lost, the motor power is also lost. Do not change the programming for AUX 1-4. These are for factory use only. AUX 5-8 are user defined outputs.

SP5.2 A relay configured as non-latching will reset itself when the cause of the trip event is not continuous. The TRIP (AUX1) relay should always be programmed for latching, because this trip should require a visual inspection of the motor and starter before issuing a manual reset to release the relay after a trip has been stored.

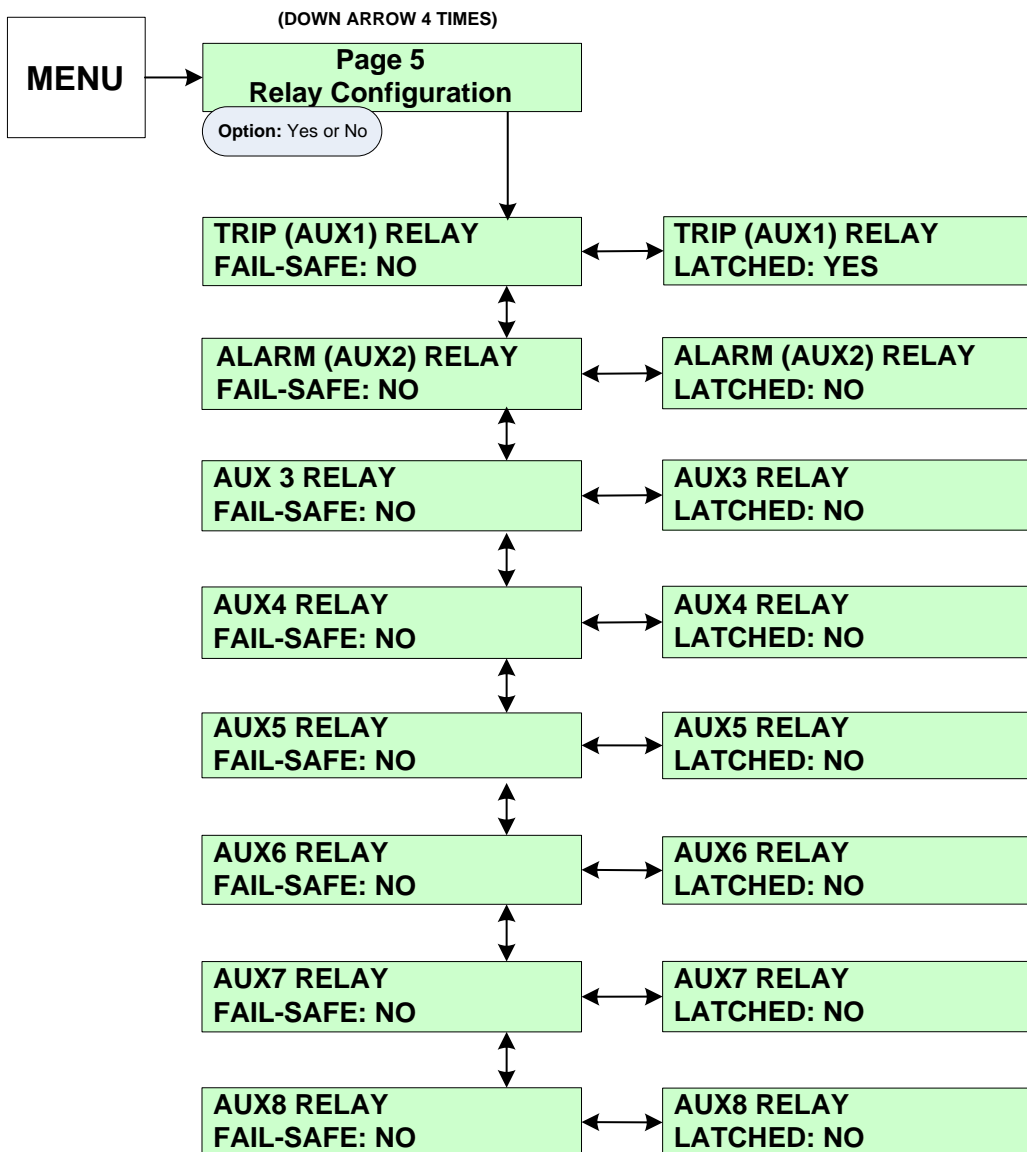

SP.6 User I/O Configuration (Setpoint Page 6)
(Security Level 2)

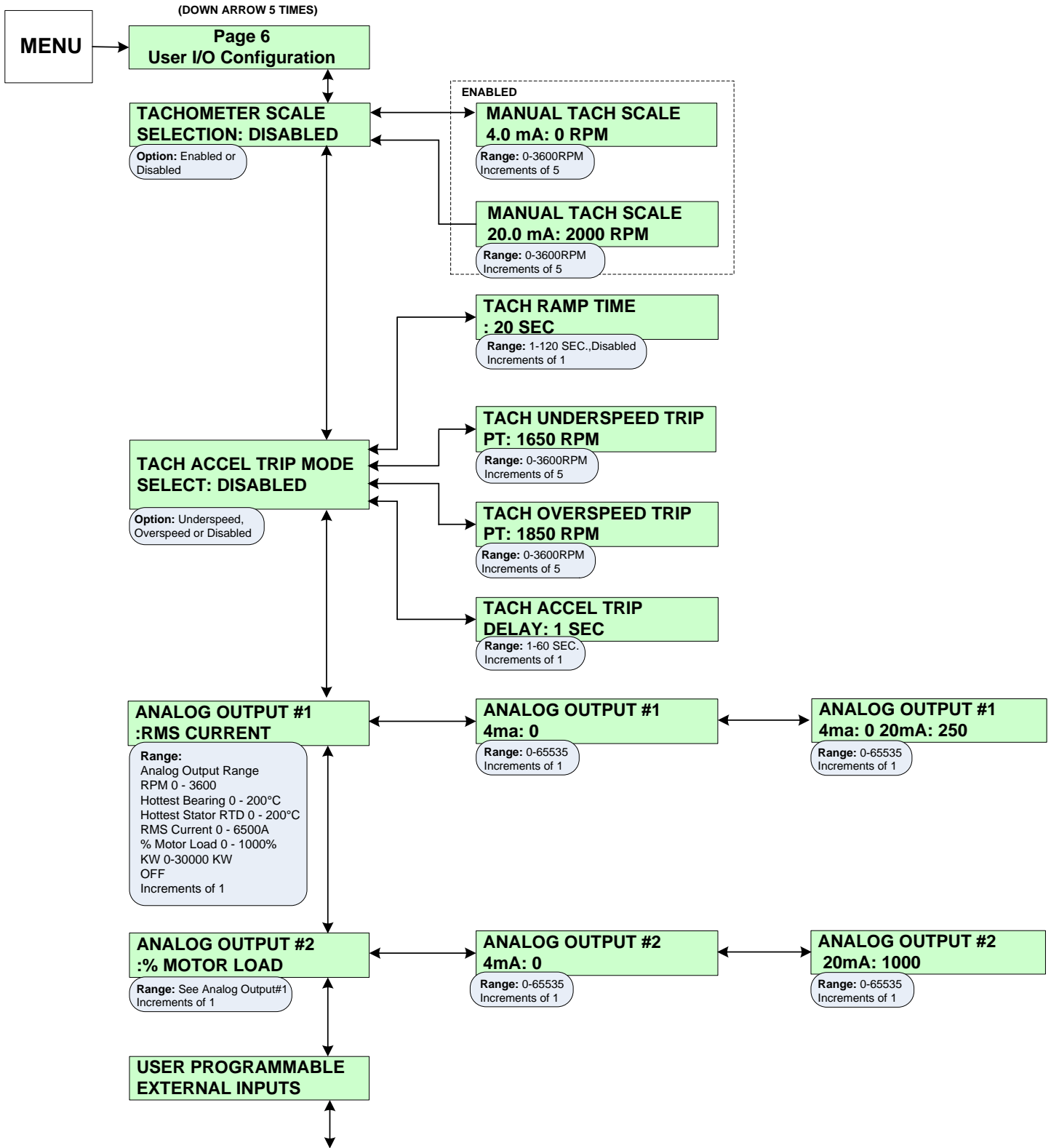

Continue on page 51

SP.6 User I/O Configuration (Setpoint Page 6) - Continued **(Security Level 2)**

The Soft Starter can be configured to accept a tachometer feedback signal using the 4-20mA input.

SP6.1 The first screen of Setpoint page 6 is TACHOMETER SCALE SELECTION. When this is set to ENABLED, the user will need to input the tachometer scale of the 4-20mA input range.

- **Manual Tach Scale 4.0 mA:** The unit is looking for an RPM value to assign to the lowest point on the scale. This Value should represent the motor at zero speed.
- **Manual Tach Scale 20.0 mA:** The unit is looking for an RPM value to assign to the highest point on the scale. This value should represent the motor at full speed.

SP6.2 Tach Accel Trip Mode Select: When enabled, the underspeed or overspeed must be selected for the Tach Accel Trip. If underspeed is selected, only the Tach Underspeed Trip Point will be used. If overspeed is selected, only the Tach Overspeed Trip Point will be used.

- **Tach Inhibit Time:** This is the duration of time before the starter begins sampling the tachometer.
- **Tach Underspeed Trip:** Defines the minimum motor speed using the Tach feedback. When the underspeed trip mode is enabled and the motor speed falls below this level for the time specified by the Tach Accel Trip Delay an underspeed trip occurs.
- **Tach Overspeed Trip:** Defines the maximum allowed motor speed using the Tach feedback. When the overspeed trip mode is enabled and the motor speed exceeds this level for the time specified by the Tach Accel Trip Delay an overspeed trip occurs.
- **Tach Accel Trip Delay:** The duration of time that the Tach Accel trip condition must persist before a trip is generated.

SP6.3 The controller provides two 4-20mA analog outputs. Each analog output is independent of the other and can be assigned to monitor different functions. The available output ranges are; RPM, Hottest Non-Stator (Bearing) RTD, Hottest Stator RTD, RMS current, and % Motor Load.

- **Analog Output #1** – Select a function from the available five options to be transmitted from the 4-20mA output.

Note: *If selecting RPM, the Tachometer feedback input signal must be present in order for the controller to give proper output. If selecting RTD, the RTD option must be installed and an RTD input signal must be present for a proper output to be given from the analog output.*

- **Analog Output #1 (4 mA):** Enter a value that the 4mA level will represent for the selected function; typically this value should be 0.
- **Analog Output #1 (20 mA):** Enter a value that the 20mA level will represent for the selected function.

SP6.4 Analog Output #2 – All of the Setpoints and setup screens for Analog Output #2 are the same as those for Analog Output #1.

SP.6 User I/O Configuration (Setpoint Page 6) - Continued
 (Security Level 2)

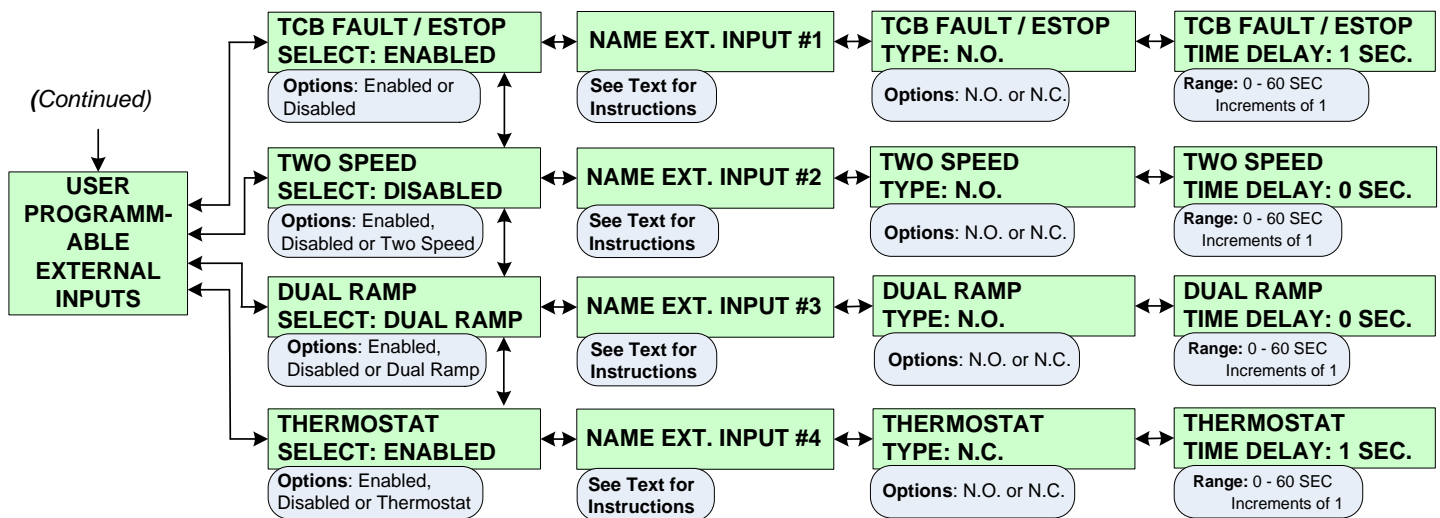

SP6.5 User Programmable External Inputs: The controller provides up to 4 digital external inputs which are individually programmable. A description name can be assigned to each individual input for easy identification.

- **TCB FAULT / ESTOP:** Factory programmed for TCB Fault/ESTOP. Input and can be enabled or disabled.
- **TWO SPEED:** Factory programmed for TWO SPEED. Input and can be enabled, disabled or Two Speed.
- **External Input #3:** The setup screens and Setpoints for External Input #3 includes the option of being configured for Dual Ramp. In Dual Ramp mode, the initial contact setting is the same as the START RAMP #1. Upon a change in input contact state, the controller will switch over to START RAMP #2 and use that setting for start control mode.

Note: The start RAMP types should only be switched while the motor is stopped. In Setpoint Page 4 Relay Assignments do not assign any output relay to this function. The controller is programmed with External input #3 programmed for dual ramp. If it is not needed, disable the dual ramp.

- **External Input #4:** Thermostat input and can be enabled, disabled or thermostat.

Note: It is recommended that this function remain enabled. If the thermostat indicates an over temperature condition, the controller will trip the motor.

External Input #1, #2, #3, #4 Time Delay: Upon a change in contact setting, the unit will wait the programmed amount of time before generating an output. If no delay is needed, then input 0 seconds. The controller will post an event upon seeing a change in state.

External Input #1, #2, #3, #4 Type: The external input can be set as either a normally open or normally closed contact.

Name Ext. Input #1, #2, #3, #4: The user can assign a description name to the input. Up to 15 characters including spaces can be used to assign the name.

SP.7 Custom Acceleration Curve (Setpoint Page 7) (Security Level 3)

SP7.1 Setpoint Page 7 allows the user to custom design the acceleration curve (start curve) for a specific application. The custom design setup allows for up to three different curves in the Soft Starter. Only one curve can be active (enabled) at any given time. Each of the three curves allow for eight voltage plotting points, with corresponding ramp times and a current limit setting.

Note: Each successive voltage level must be programmed to a voltage level equal to or greater than the previous level. All eight voltage levels must be programmed and the eighth level has been preset at 100%.

- If Custom Accel Curve has been set to curve A, B or C on this page, the Soft Starter will override the Start Control Mode selected in Setpoint Page 2, (even if Start Control Mode in Setpoint Page 2 has not been set to Custom Accel Curve).

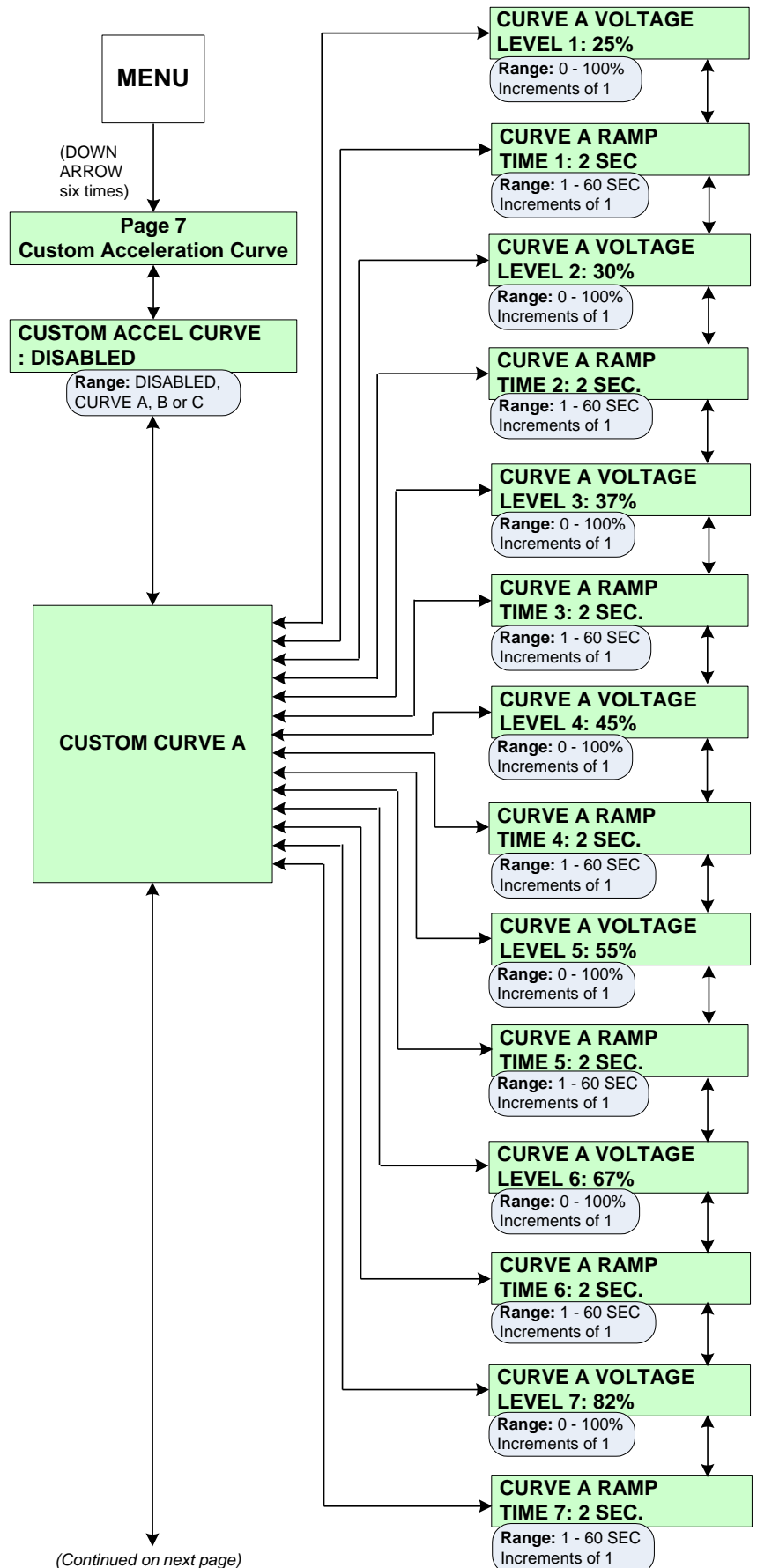

(Continued on next page)

SP.7 Custom Acceleration Curve (Setpoint Page 7) - Continued
 (Security Level 3)

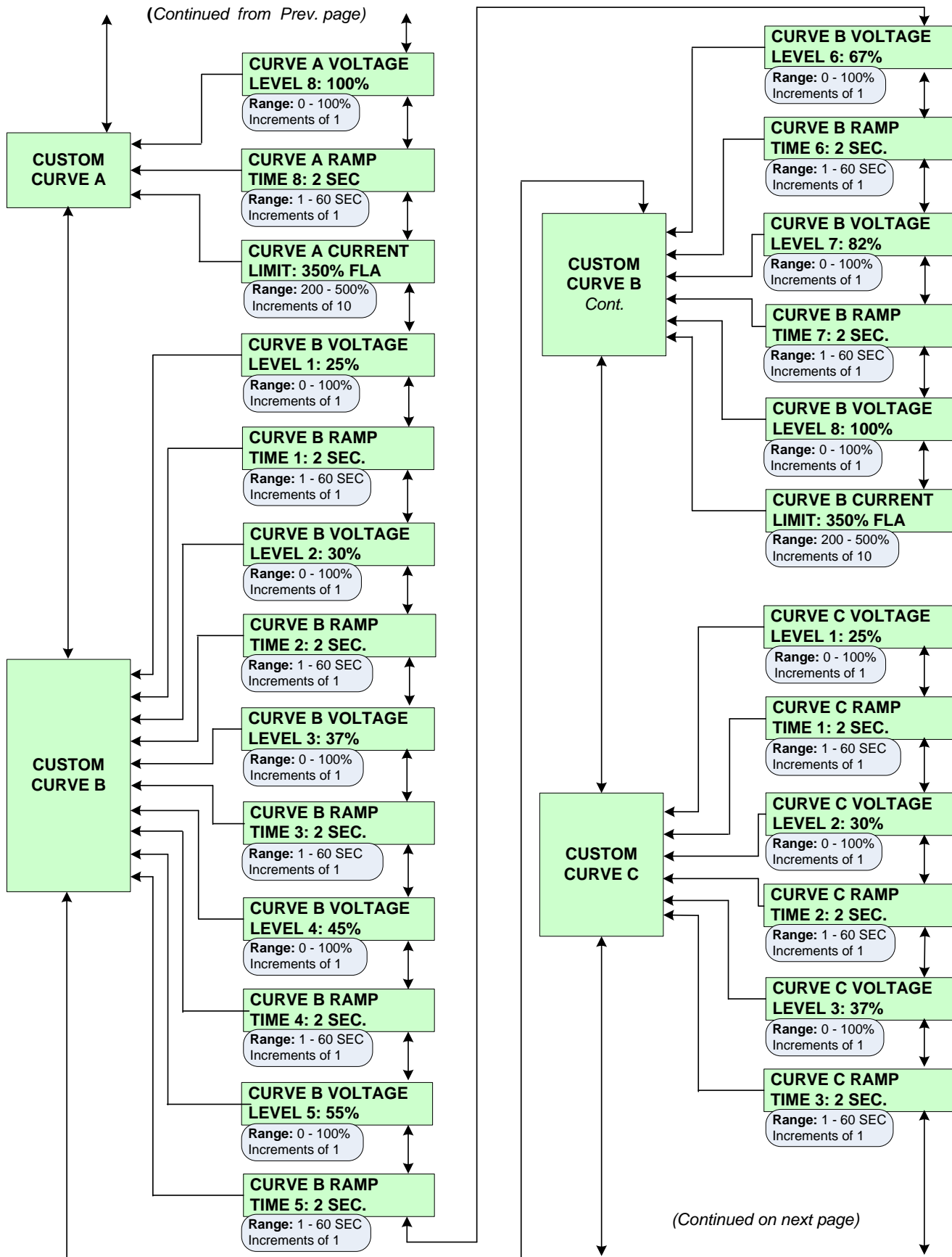

SP.7 Custom Acceleration Curve (Setpoint Page 7) - Continued
(Security Level 3)

(Continued from prev. page)

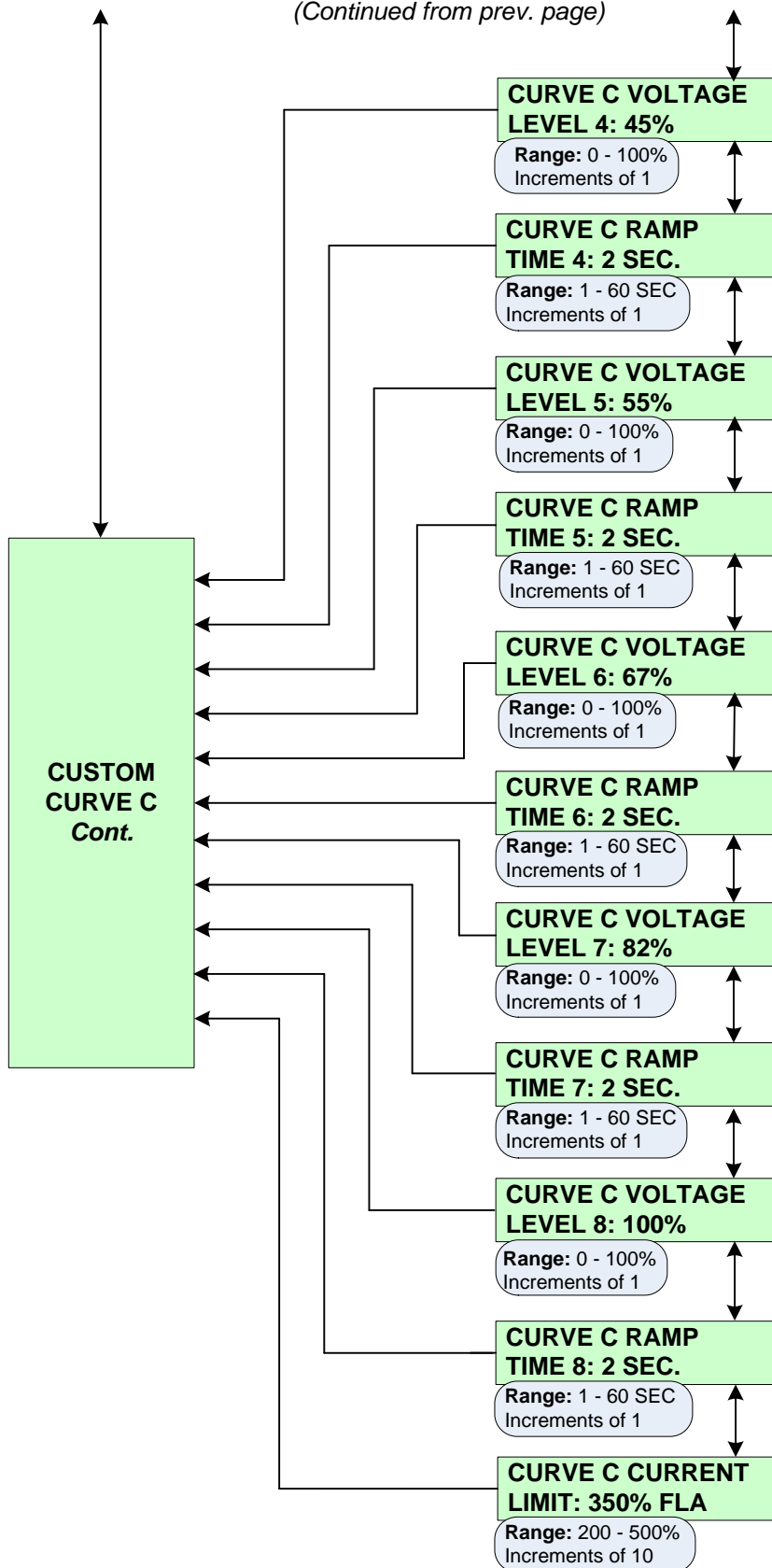

SP.8 Overload Curve Configuration (Setpoint Page 8) (Security Level 3)

Configures the unit's start and run protection mode. The unit has independent start and run curve protection and the settings can be based on the OL Class or set by the motor's locked rotor current and time.

SP8.1 Basic Run Overload Curve

- **Run Curve Locked Rotor Time:** Set the locked rotor time to the OL Class default chosen in Setpoint Page 1 or set the time in seconds. This is the time the locked rotor condition exists before a trip occurs.
- **Run Locked Rotor Current:** The current the motor draws with full voltage on the windings and no rotor movement (as a percent of motor FLA). Refer to the nameplate data or contact the motor manufacturer.
- **Coast Down Timer:** If enabled, this prevents the motor from restarting for the programmed amount of time, after a stop command is given.

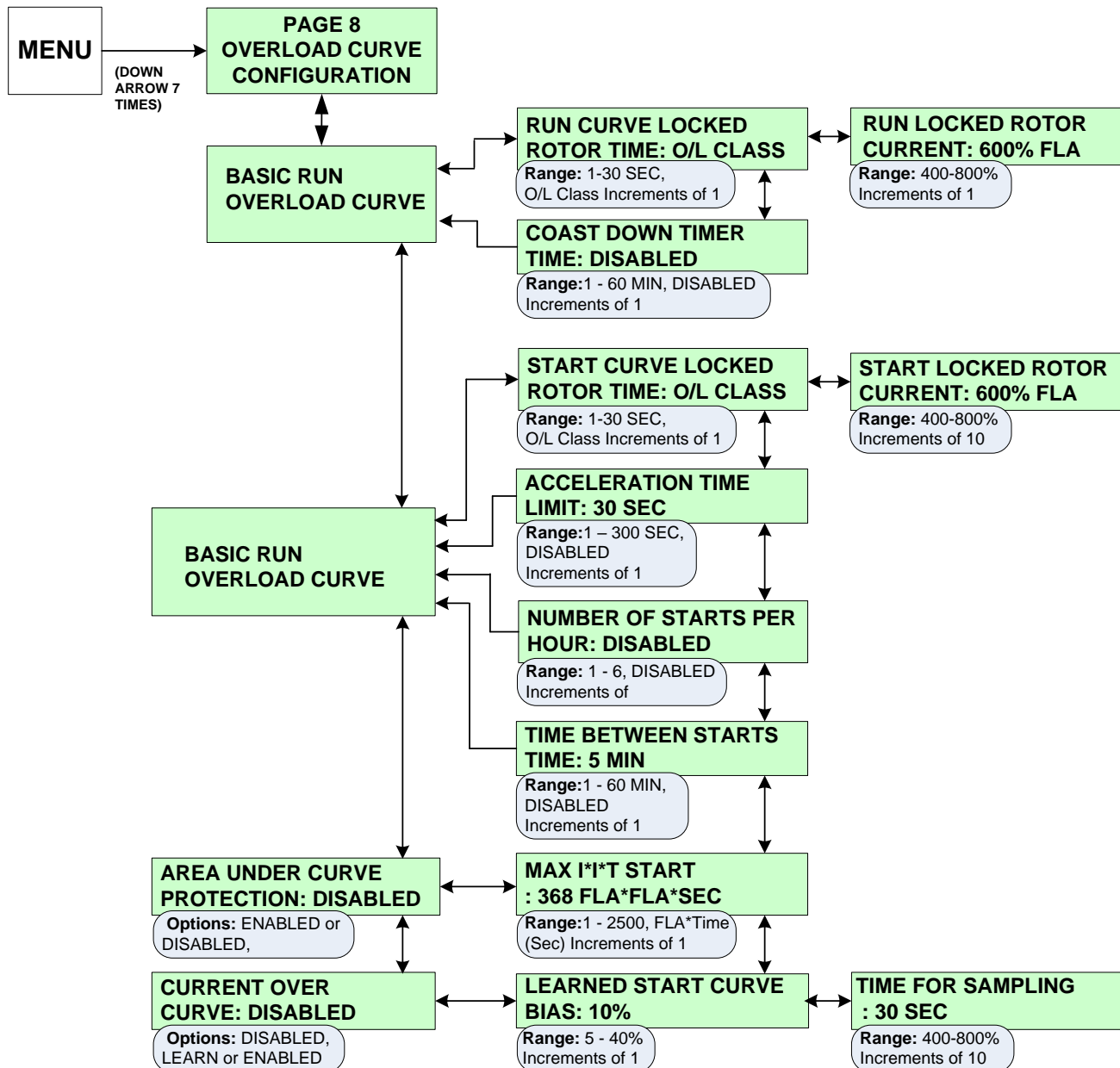

SP8.2 Basic Start Overload Curve

- **Start Curve Locked Rotor Time:** The locked rotor time can be set to the OL Class default chosen in Setpoint Page 1 or to a specific time. The overload condition must exist for the programmed amount of time before a trip occurs.
- **Start Locked Rotor Current:** The current the motor draws with full voltage on the windings and no motor movement (as a percent of motor FLA). Refer to the motor nameplate data or contact the motor manufacturer.
- **Acceleration Time Limit:** If the motor does not enter run mode (reach “at speed”) within the preset time, the unit trips on acceleration time limit.
- **Number of Starts per hour:** If enabled, this limits the maximum number of starts permitted per hour. This Setpoint allows a maximum of 6 starts per hour. Contact the motor manufacturer for further information regarding number of starts per hour.
- **Time Between Starts:** If enabled, the soft starter prevents another start attempt until the programmed time has expired.

SP8.3 Area Under Curve Protection: If enabled, this secondary start protection uses both the basic start protection and the area under the curve protection.

- **Max I²t Start:** The maximum I²t allowed during start. If the I²t to start exceeds this number then the Soft Starter will generate a trip.

SP8.4 Current Over Curve: Learns the motor’s starting characteristics and protects the motor based upon the learned curve. It is useful when commissioning a new motor.

- **Learn:** The unit reads the motor’s starting characteristics. Start the motor and allow it to come to full speed. The start feedback enables the motor protection based on the learned start curve.
- **Learned Start Curve Bias:** The maximum allowed deviation above or below the start curve before a trip is generated.
- **Time for sampling:** The time the soft starter continues to sample the start curve characteristic during learn mode.

SP.9 RTD Option Configuration (Setpoint Page 9) (Security Level 3)

Note: The RTD is an option. Contact factory for additional information.

The Soft Starter is available with an optional RTD card that provides 12 programmable RTDs which are individually programmable for type. The available types are 100 ohm platinum, 100 ohm nickel, 120 ohm nickel and 10 ohm copper. Each RTD can be identified with a description name of up to 15 characters (including spacing). Also, each individual RTD has its own alarm and trip level.

SP9.1 Use NEMA Temp for RTD Value:

When this Setpoint is enabled, the Soft Starter will use the NEMA design insulation class to limit the maximum allowed range of the alarm and trip level. The maximum allowed temperature range is 240° C or (464°F).

SP9.2 Number Of RTD'S Used for Stator:

Up to six RTDs can be assigned to monitor the stator of the motor.

SP9.3 RTD Voting:

When this is enabled, the Soft Starter will not post a trip until 2 RTD's have exceeded the trip level. This prevents nuisance RTD tripping.

SP9.4 RTD Setup:

Each of the 12 RTDs is configured in the following manner. The first column is the RTD type, the second column is the RTD description, the third column is the alarm level, and the fourth column is the trip level. The first six RTDs have been pre-programmed with a description name for the STATOR, with two RTDs per phase.

RTDs #1 & #2 have been named STATOR PHASE A1 and A2 respectively. RTDs #3 & 4 are named STATOR PHASE B1 and B2, RTDs #5 & 6 are named STATOR PHASE C1 and C2.

If other description names are required, press the right arrow button from the RTD Type screen to go the RTD description screen. If no alarm or trip level is required these Setpoints can be turned off.

RTD Available Settings:

RTD TYPE:

- 120 OHM NICKEL (NI)
- 100 OHM NICKEL (NI)
- 10 OHM COPPER (CU)
- 100 OHM PLATINUM (PT)
- OFF

ALARM LEVEL: OFF or 0 - 240C (32-464F) Example: ### C = ### F, Increments of 1

RTD DESCRIPTION:

STATOR A1, STATOR A2, STATOR B1, STATOR B2, STATOR C1, STATOR C2, FRONT BEARING, BACK BEARING, BEARING BOX, AMBIENT, NONE

RTD ALARM DELAY: Entry allows the enunciation of the Alarm condition to be delayed by the set time to ensure an alarm condition persists.

Factory Setting = 5 sec.

Range = 1 - 60 sec.

RTD TRIP DELAY: This entry will allow the RTD Trip function to be delayed by the set time.

Factory Setting = 10 sec.

Range = 1 - 60 sec.

SP.9 RTD Option Configuration (Setpoint Page 9) - Continued
(Security Level 3)

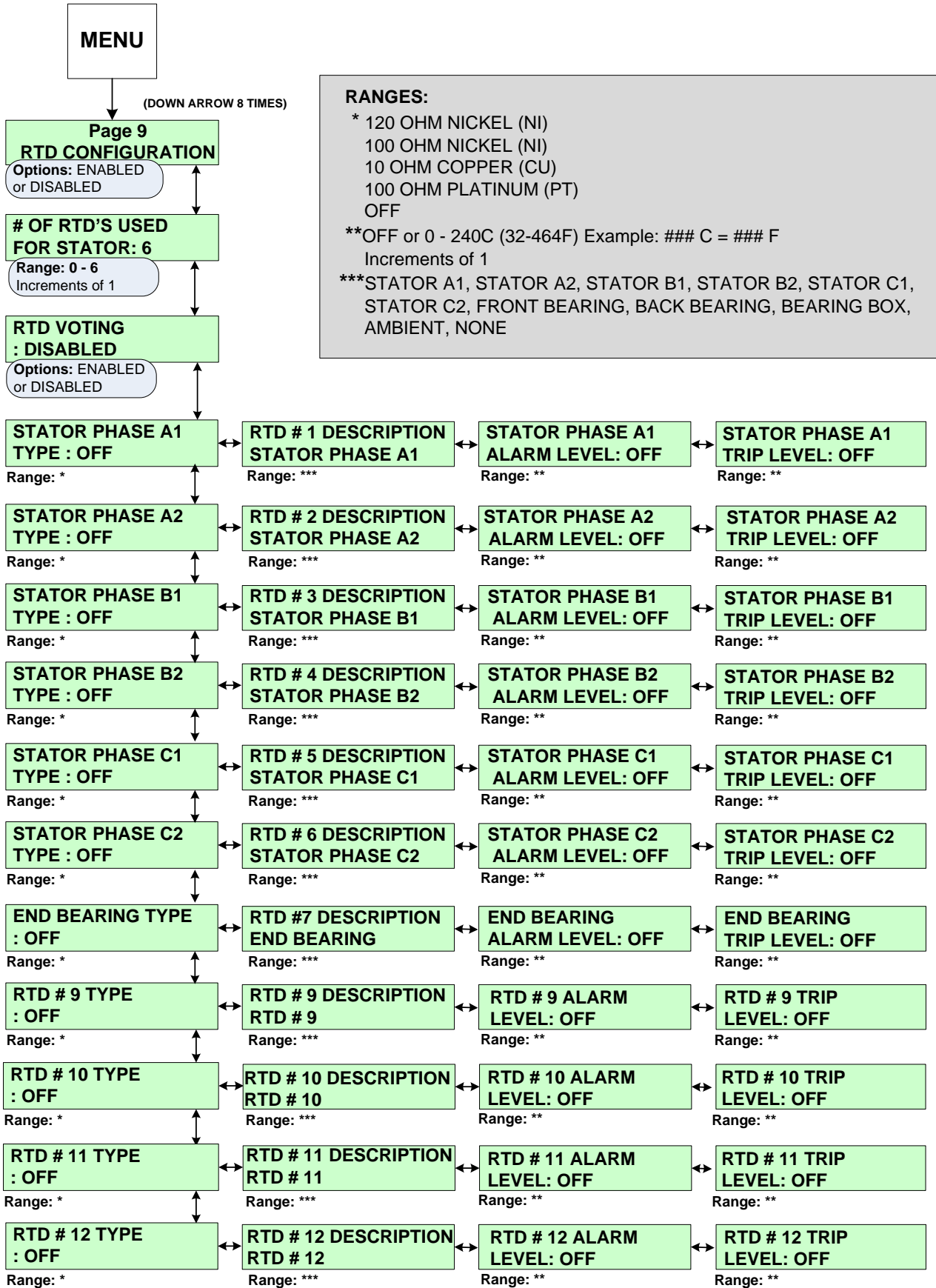

SP.9 RTD Option Configuration (Setpoint Page 9) - Continued
(Security Level 3)

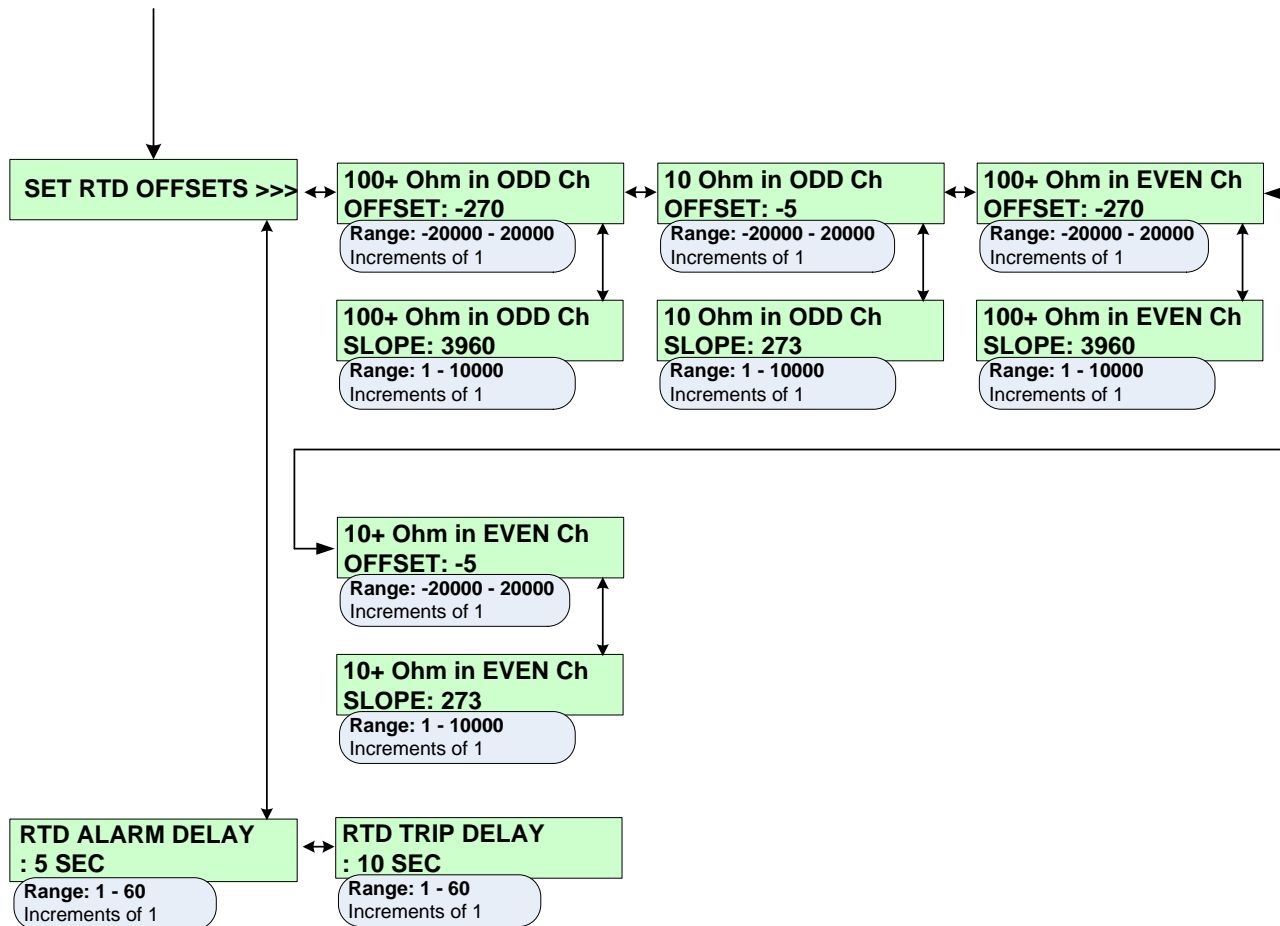

SP.10 Set Password (Setpoint Page 10)
(Security Level 3)

The soft starter has three levels of user programmable setpoint screens. Level one setpoints do not require a password because the data contained in level one is basic nameplate data and starter control. Level two setpoint screens require a three-digit password to configure the protection schemes. Level three setpoint screens require a four-digit password to access the full range of protection and starter schemes.

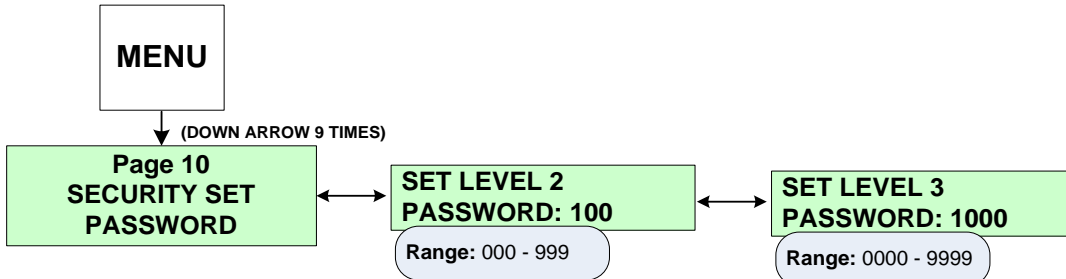

SP10.1 Set Level 2 Password: This level uses a 3-digit password. The default level 2 password is 100.

SP10.2 Set Level 3 Password: Level three uses a 4-digit password. The default level 3 password is 1000.

SP.11 Communications (Setpoint Page 11)
(Security Level 3)

SP11.1 Set Front Baud Rate: Configures the RS232 communications baud rate.

SP11.2 Set Modbus Baud Rate: Configures the Modbus communications baud rate

SP11.3 Modbus Address Number: Assigns a Modbus address to the unit.

SP11.4 Set Access Code: Assigns an access code to the Modbus addressing. This is typically not used

SP11.5 Set Link Baud Rate: Configures the RS422 communications baud rate between the keypad operator and the CPU board (For applications with remote keypad only).

SP11.6 Remote Start/Stop: Allows the RS485 Modbus communications to start and stop the motor. Contact factory for details.

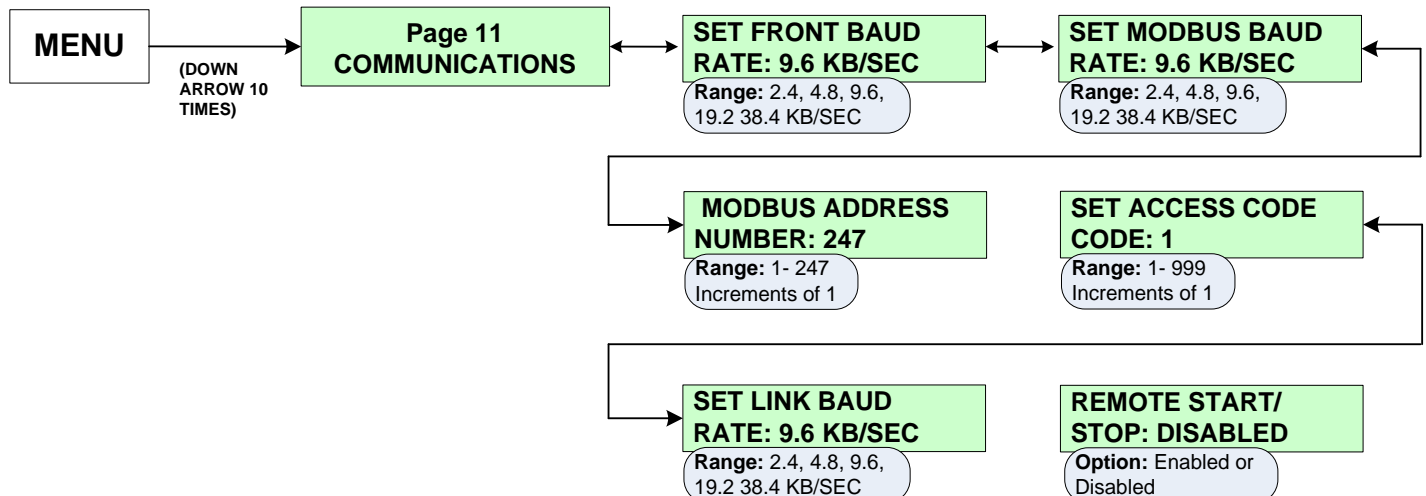

SP.12 System Setpoints (Setpoint Page 12) **(Security Level 3)**

SP12.1 Default Display Screen: This Setpoint group allows the user to choose the default screen the Soft Starter displays while the motor is running. Select the metering page number (1-3), then, select the metering screen number. The range varies depending on the selected page. To display a default screen, program the following two Setpoints:

- **Metering Data Page#:** Range is Page 1 - 3.
- **Metering Data Screen#:** If Page 1 is selected as the default page, then Screens 1- 10 are available. If Page 2 Screens 1-29 are available. If Page 3 is selected then Screens 1-6 are available. (See Metering Menu, MP.1, for screen number assignment.)

SP12.2 Alarms: Configures the RTD failure alarm (when RTD option is included) and the thermal register alarm.

- **RTD Failure Alarm:** If enabled, and an RTD shorts or open, an alarm occurs. (Only if RTD option is installed).
- **Thermal Register Alarm:** Sets a level in the thermal register to generate an alarm when the Thermal Register Capacity Used has exceeded this level.
- **Thermal Alarm Delay:** The amount of time that the Thermal Register Used must exceed the Setpoint before an alarm condition will occur.

SP12.3 Thermal Register Setup Information: This Setpoint group will configure the thermal register and indicate to the soft starter which inputs to use when thermal modeling.

- **Cold Stall Time:** Enter the time from the motor manufacturer's specification sheet or use the time defined by the OL Class. This Setpoint is used to define the thermal capacity of the motor.
- **Hot Stall Time:** Enter the amount of time specified by the motor manufacturer or use half of the time defined by the OL Class.
- **Stopped Cool Down Time:** The time the motor needs to cool down after it has stopped. Use only the data provided by the motor manufacturer. This Setpoint is used to configure the cooling rate of the thermal register.
- **Running Cool Down Time:** The amount of time the motor needs to cool down while running. Use only the data provided by the motor manufacturer.
- **Relay Measured Cool Rates:** When the RTD option is supplied, the Soft Starter can be configured to use the measured cooling rates from the RTDs instead of the programmed settings. This Setpoint should only be enabled when the RTD option is present.
- **Thermal Register Minimum:** Sets the value in the thermal register which represents a motor running at the nameplate current (with no overheating or negative sequence currents present).
- **Motor Design Ambient Temperature:** Use the data from the motor manufacturer's specifications. When RTD option is supplied, this Setpoint will be the base point for the RTD biasing of the Thermal Register.
- **Motor Design Run Temperature:** Use the data from the motor manufacturer's specifications. This Setpoint defines the operating temperature rise of the motor at full load amps or 100% load.
- **Motor Stator Max Temperature:** This represents the maximum temperature the stator insulation will withstand. The user may choose to use the temperature setting of the insulation class (selected in Setpoint Page 1) or enter a specific maximum temperature. This value should not exceed the stator's insulation temperature. This maximum temperature represents 100% thermal capacity.
- **U/B Input to Thermal Register:** Always enabled. It allows the soft starter to use the line current imbalance information to bias the Thermal Register.

- **User Calculated K or Assign:** When the Setpoint is set to ON, the soft starter will calculate the k constant factor for biasing the thermal register, or the user may choose to assign the k value.
- **SP12.4 Press Enter to CLR Thermal Register:** Allows the level three password user to clear the thermal register for emergency restarts.

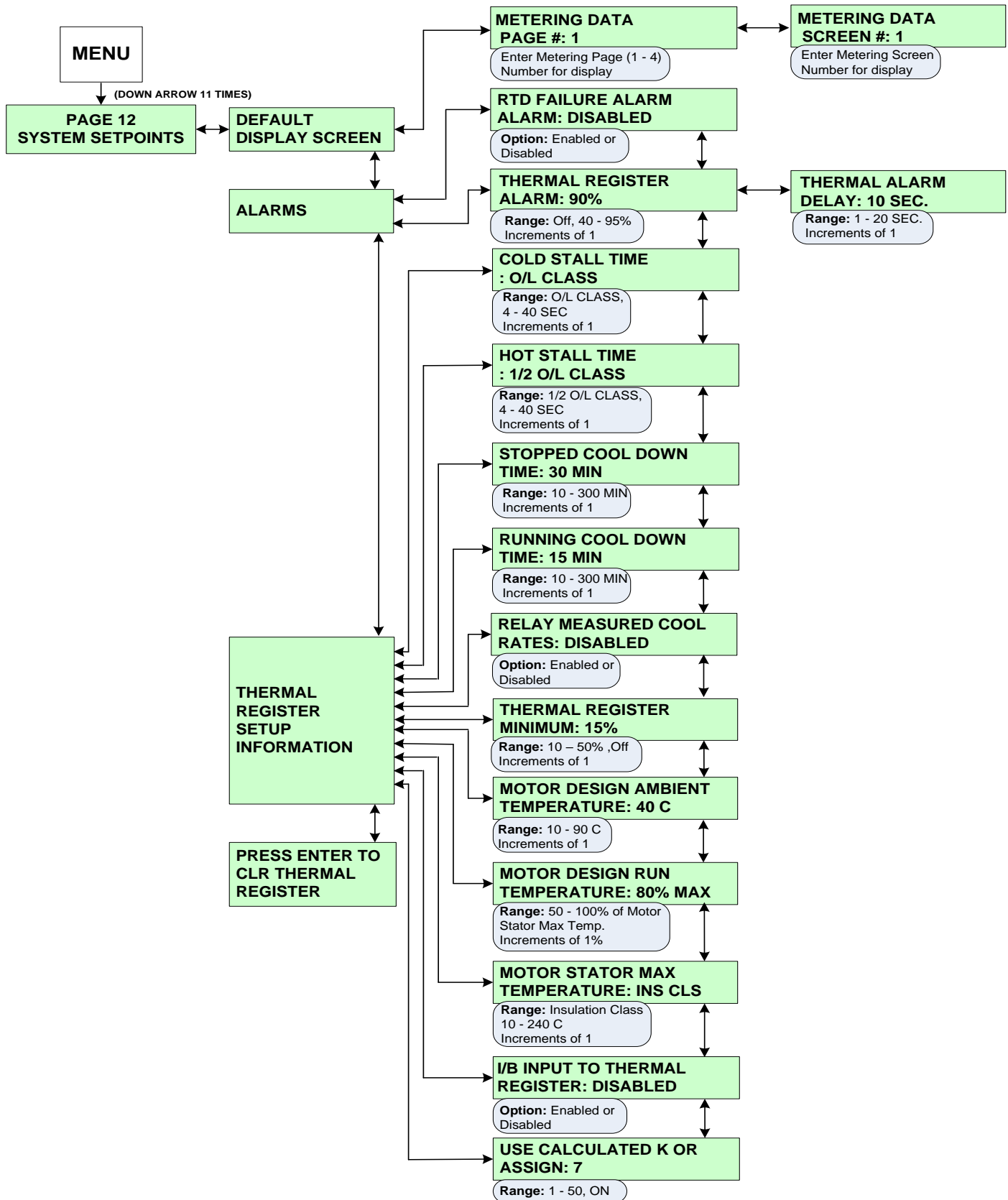

SP.13 Calibration & Service (Setpoint Page 13)

(Security Level 3)

Certain screens are displayed for user information only, such as Current date and time, Model number and Firmware revision number. *Setpoint changes in this page will only be accessible to factory personnel.*

SP13.1 Set Date and Time: Displays the date and time.

- **Enter Date (DDMMYYYY):** Allows the factory personnel to program the date for the soft starter in the format shown.
- **Enter Time (HH:MM):** Allows the factory personnel to program the time for the soft starter.

SP13.2 Model & Firmware #: Displays the model number and firmware revision in the soft starter.

SP13.3 Press Enter to Access Factory Settings: Available to qualified personnel.

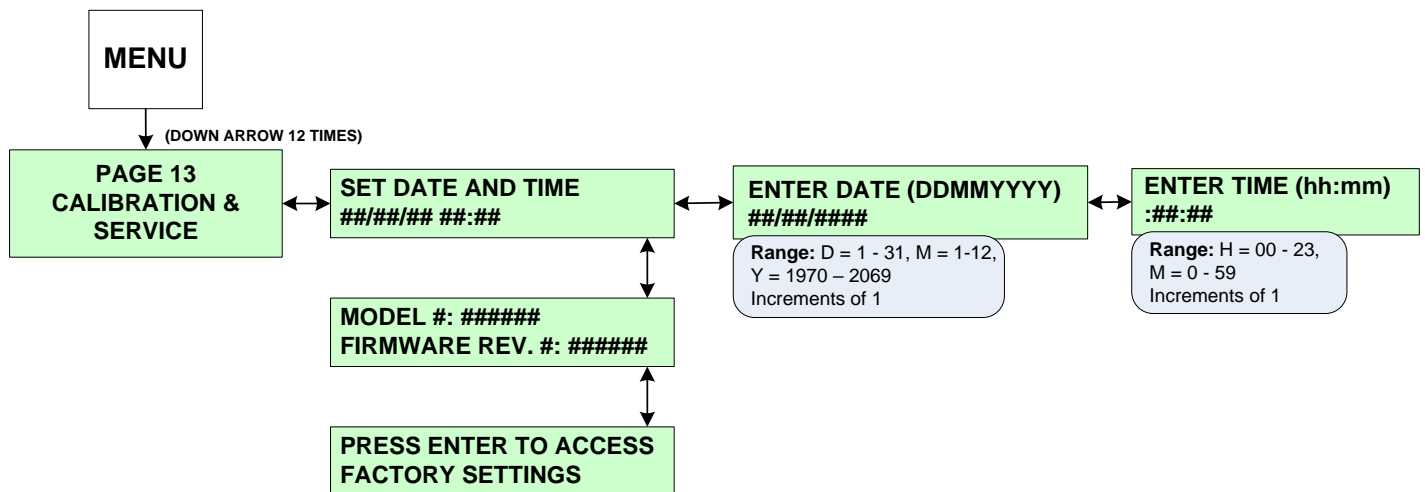

Chapter 6 - Metering Pages

The Soft Starter offers performance metering which gives the user the ability to view information about the motor and the unit.

6.1 Metering Page List

The following charts list each Metering Page and the functions within that page. The applicable section of the manual is also referenced.

6.1.1 Metering Menu & Data (Metering Page 1)

Metering Page	Description of Display	Screen
PAGE 1 Metering Menu & Data	Phase A, B, C and Ground Fault (Option)	1
	Average current of the % of imbalance and the motor's RPM (Tach Option)	2
	Motor load as a percentage of motor FLA	3
	Line frequency and present phase sequence	4
	Percentage of remaining Thermal Register	5
	Thermal capacity required to start the motor	6
	Average time required to start	7
	Average current during start	8
	Measured I ² T required to start the motor	9
	Amount of time required to start the motor during the last successful start	10

6.1.2 Metering (Metering Page 2)

Metering Page	Description of Display	Screen
PAGE 2 Metering	Phase A, B, C currents and Power Factor	1
	Phase A, B, C currents and Ground Fault (Option)	2
	Displays KW and KVA	3
	Displays KVAR and Power Factor	4
	Displays Peak ON and KW Demand	5
	Displays Peak ON and KVA Demand	6
	Displays Peak ON and KVAR Demand	7
	Displays Peak ON and Amps Demand	8
	Clears Demand values	9
	Displays Megawatt hours used	10
	Press enter to clear statistics on MWH values	11

6.1.3 RTD Option Values (Metering Page 3)

Metering Page	Description of Display	Screen
PAGE 3 RTD Values	Hottest stator RTD (#1 - 6)	1
	Hottest non-stator RTD (#7 - 12)	2
	Temperature of start phase A1 in °C and °F	3
	Maximum temperature for RTD #1	4
	Same as Screens 3 - 4 for RTDs #2 - 12	5 - 26
	Clear the maximum temperature register (Level 3 password required)	27
	Measured running thermal stabilization time of motor (in minutes)	28
	Measured stopped cooling time (to ambient) of motor (in minutes)	29

6.1.4 Status (Metering Page 4)

Metering Page	Description of Display	Screen
PAGE 4 Status	Current status	1
	Amount of time remaining before an overload trip occurs	2
	Amount of time remaining from a thermal inhibit signal	3
	Coast down time remaining	4
	Amount of time remaining before a start command can be given	5
	Excessive number of starts per hour	6

6.1.5 Event Recorder (Metering Page 5)

Metering Page	Description of Display	Screen
PAGE 5 Event Recorder	Displays the event with date and time (Up to 60 events)	1
	Displays Phase A, B, C current values, Ground Fault (Option) at time of trip	1A
	Displays Vab, Vbc, Vca and Power Factor at time of trip	1B

6.1.6 Last Trip (Metering Page 6)

Metering Page	Description of Display	Screen
PAGE 6 Last Trip	Cause of last trip	1
	Measured phase current	2
	Measured voltage and power factor	3
	Imbalance percentage, the frequency and the kW	4
	Hottest stator RTD temperature	5
	Hottest non-stator RTD temperature	6

6.1.7 Statistics (Metering Page 7)

Metering Page	Description of Display	Screen
PAGE 7 Statistics	Total Megawatt Hours	1
	Accumulated Total Running Hours	2
	Clear the Total Running Hour Count	3
	Total Number of Trips / Number of Short CircuitTrips	4
	Number of Start and Run Overload Trips since the last statistical data clearing	5
	Number of frequency and Current Imbalance trips	6
	Number of Over Current Trips	7
	Stator and Non-Stator RTD Trips	8
	Ground Fault Hiset and Loset Trips	9
	Acceleration Time Trips	10
	Start Curve Trips	11
	I ² T Start Curve Trips	12
	Learned Start Curve Trips	13
	Shunt Trip Trips	14
	Phase Loss Trips	15
	Tach Acceleration Trips	16
	Undervoltage and Overvoltage Trips	17
	Power Factor Trips	18
	Phase Reversal Trips	19
	Low Control Voltage Trips	20
	Ext Inp #1 Trips	21
	Ext Inp #2 Trips	22
	Ext Inp #3 Trips	23
	Ext Inp #4 Trips	24
	Press ENTER to Clear Statistics	25

6.2 Metering Menu and Explanation

Push MENU key to toggle the screens between Setpoint Menu and Metering Menu and follow the arrow keys to get to different screens.

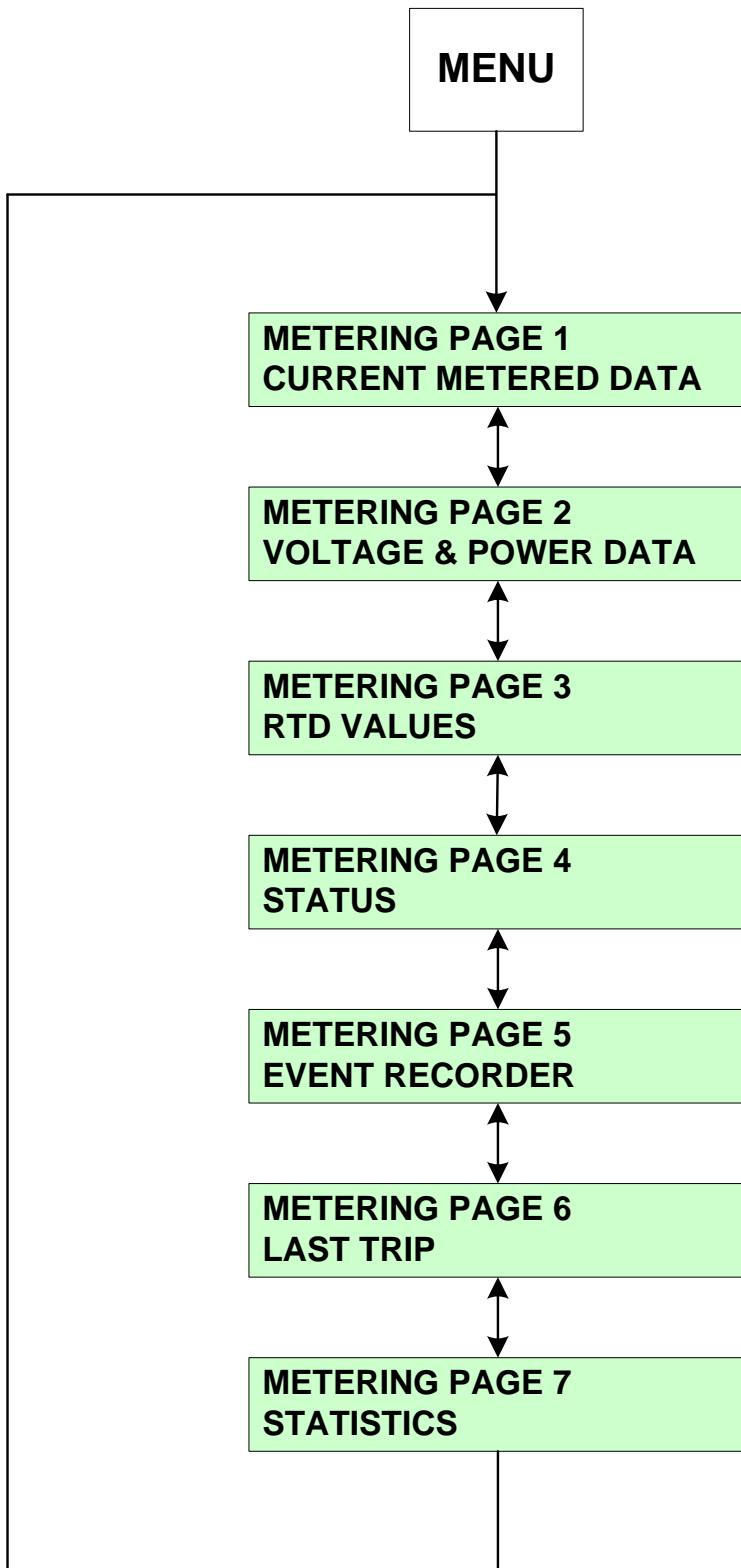

MP.1 Metering (Metering Page 1)

Displays basic current metering data.

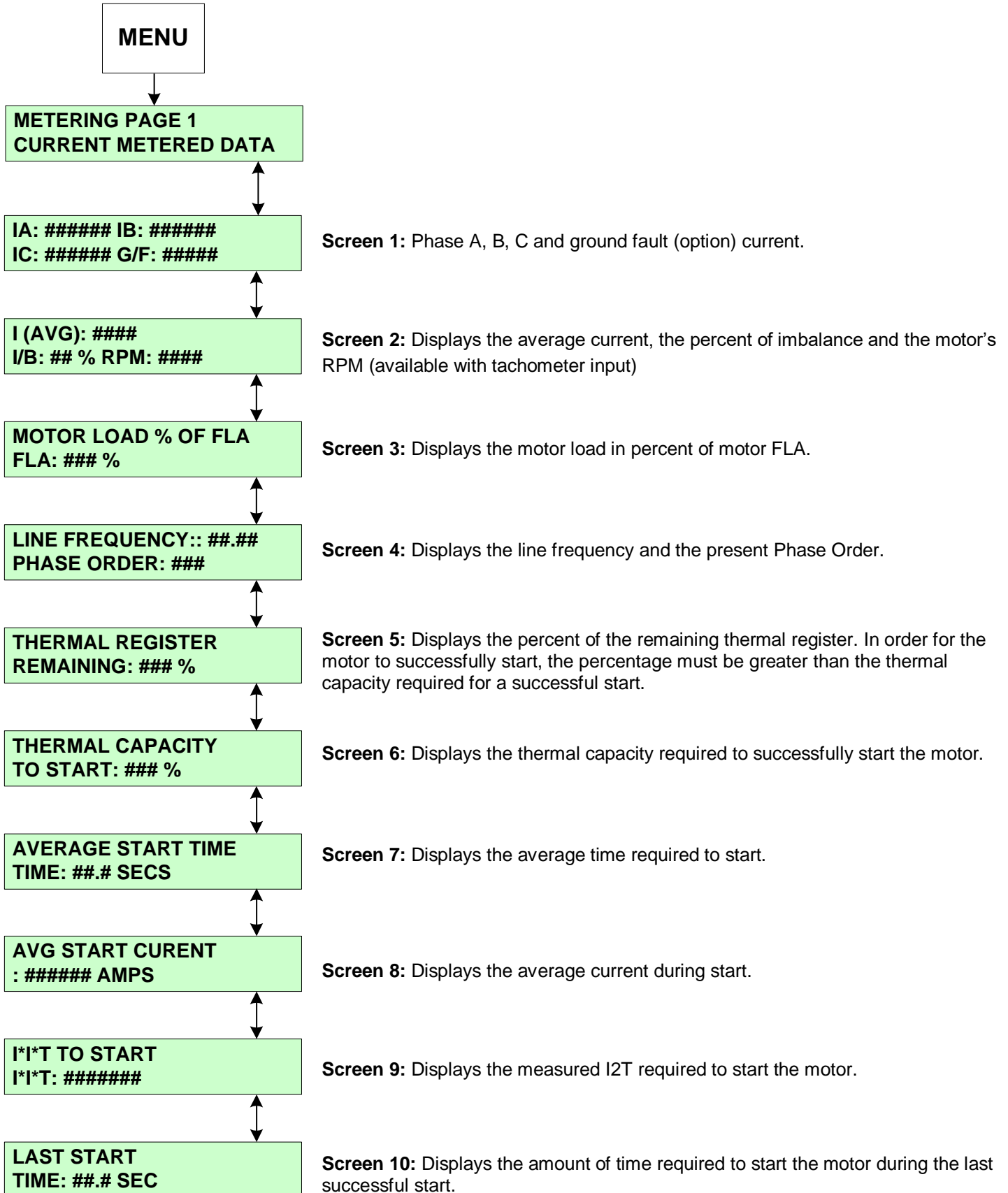

MP.2 Metering (Metering Page 2)

Displays the soft starter statistical voltage metering information

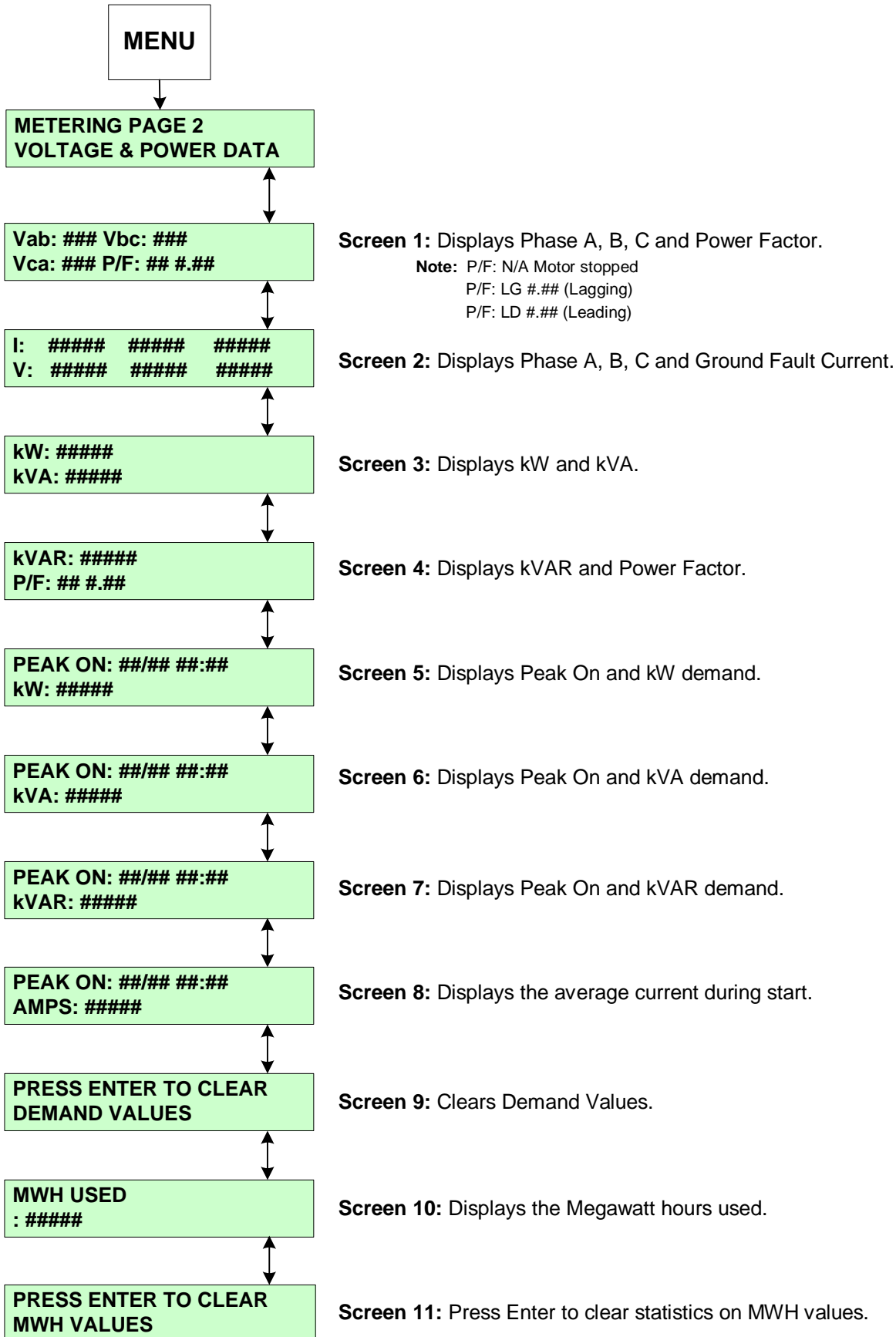

MP.3 Metering (Metering Page 3)

Displays the RTD information (When RTD option is installed)

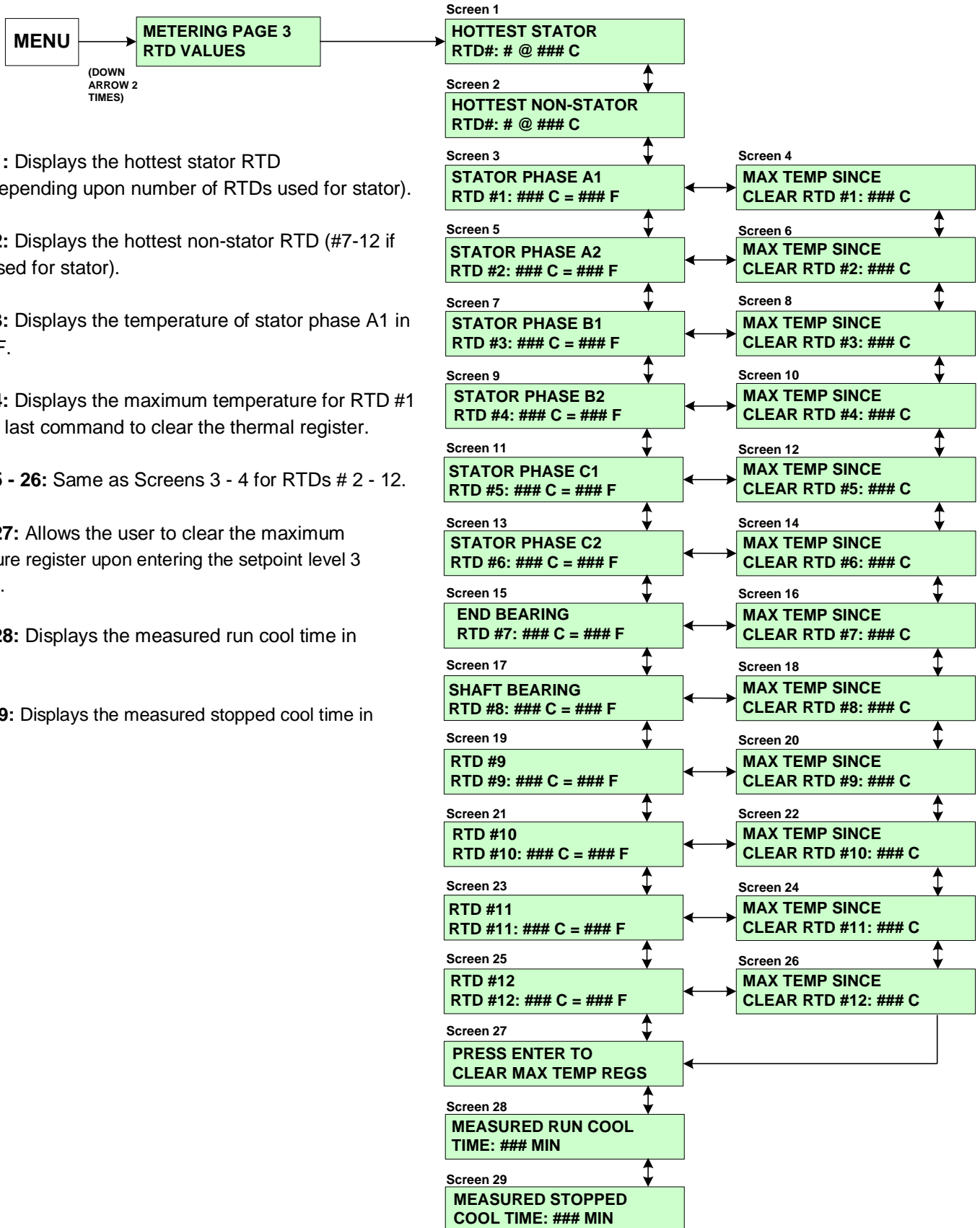

Screen 1: Displays the hottest stator RTD (#1 – 6 depending upon number of RTDs used for stator).

Screen 2: Displays the hottest non-stator RTD (#7-12 if #1-6 is used for stator).

Screen 3: Displays the temperature of stator phase A1 in °C and °F.

Screen 4: Displays the maximum temperature for RTD #1 since the last command to clear the thermal register.

Screen 5 - 26: Same as Screens 3 - 4 for RTDs # 2 - 12.

Screen 27: Allows the user to clear the maximum temperature register upon entering the setpoint level 3 password.

Screen 28: Displays the measured run cool time in minutes.

Screen 29: Displays the measured stopped cool time in minutes.

MP.4 Metering (Metering Page 4)

Displays the present status of the soft start

***Screen 1:** Displays the present state of the unit as follows:

Screen 2: Displays the amount of time remaining before an overload trip will occur.

Screen 3: Displays the amount of time remaining from a thermal inhibit. The inhibit time comes from the amount of thermal register remaining versus the amount of thermal capacity required to start.

Screen 4: Displays the coast down time remaining (Backspin time). The time remaining depends upon the user setting in Setpoint Page 8, Coast Down Time.

Screen 5: Displays the amount of time remaining before a start command can be given. The time remaining depends upon the setting in Setpoint page 5.

Screen 6: If the number of starts per hour has exceeded the setting in Setpoint page 8.

*** NOTE: Screen 1 CURRENT STATUS Screens include:**

MOTOR STOPPED
READY TO START

MOTOR STARTING
MULT. OF FLA

MOTOR RUNNING
AT ###.## X FLA

LAST TRIP CAUSE
NONE (or trip cause)

PROGRAMMING
SETPOINTS

MOTOR STATUS
UNKNOWN STATE ###

(Displays relay state upon error)

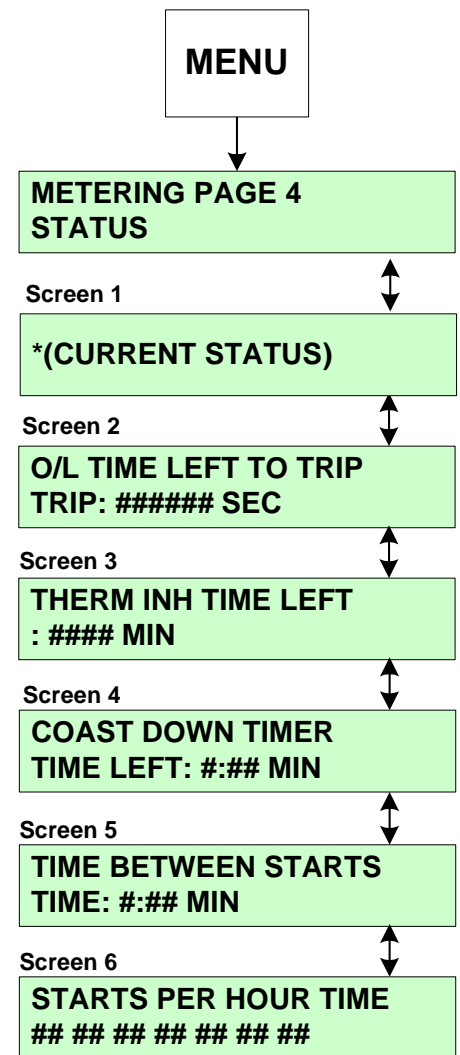

MP.5 Metering (Metering Page 5)

Displays the present status of the soft start

Screen 1: Displays the event (i.e., Imbalance Trip) with the date and time it occurred.

Screen 1a: Displays the current at Phase A, B, C and the ground fault at the time of the event. (**Note:** Ground fault option must be present)

Screen 1b: Displays the Vab, Vbc, Vca and power factor at the time of event.

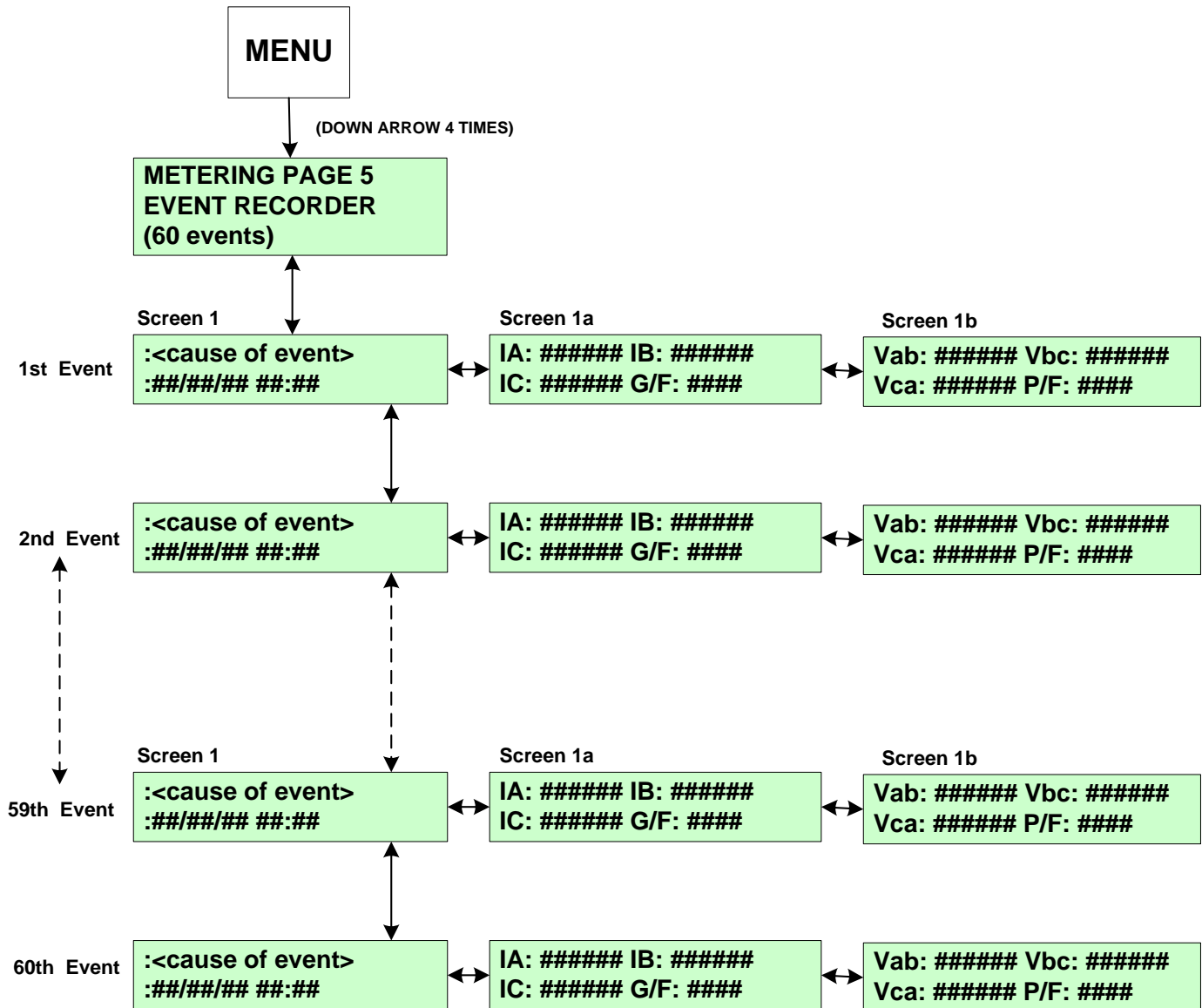

All events will be viewed from oldest event in buffer to most recent event.

NOTES-

MP.6 Metering (Metering Page 6)

Displays the last trip information

Screen 1: Displays the cause of the last trip.

Screen 2: Displays the measured phase current at the time of the trip.

Screen 3: Displays the Vab, Vbc, Vca and power factor at the time of trip.

Screen 4: Displays the imbalance percentage, the frequency and the kW at the time of the trip.

Screen 5: Displays the hottest stator RTD temperature (when RTD option present) at time of the trip.

Screen 6: Displays the hottest non-stator RTD temperature (when RTD option present) at the time of the trip.

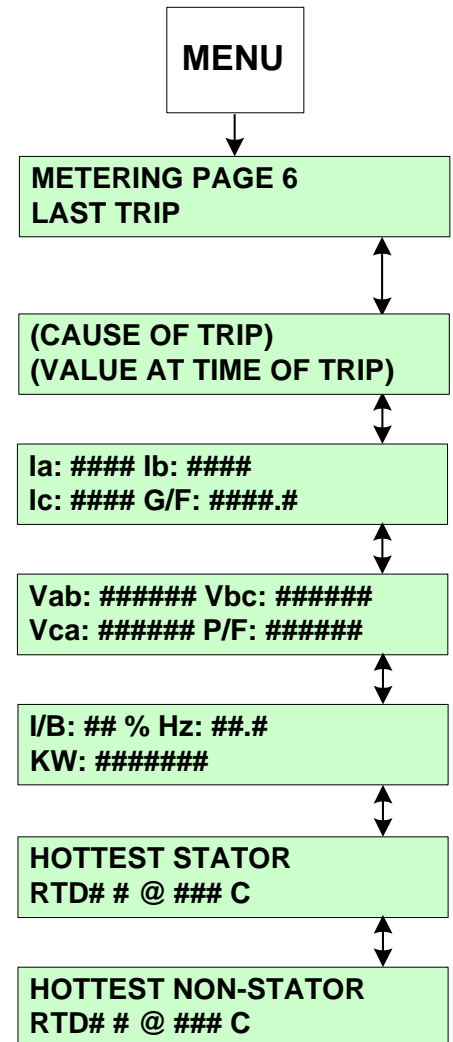

MP.7 Statistics (Metering Page 7)

Displays the statistical trip information

Screen 1: Displays the total of megawatt hours.

Screen 2: Displays the accumulated total running hours.

Screen 3: Clears the total running hour count.

Screen 4: Displays the total number of trips since the last clearing of the statistical data and the total number of short circuit trips.

Screen 5: Displays the number of start overload and run overload trips since the last clearing of the statistical data.

Screen 6: Displays the number of frequency trips and Imbalance trips.

Screen 7: Displays the number of overcurrent trips

Screen 8: Displays the number of Stator and non-Stator RTD Trips

Screen 9: Displays the number of Ground Fault Hi and Lo Set trips

Screen 10: Displays the number of acceleration time trips.

Screen 11: Displays the number of start under curve trips

Screen 12: Displays the number start over curve trips

Screen 13: Displays the number of I2T start curve trips

Screen 14: Displays the number of learned start curve trips.

Screen 15: Displays the number of fail shunt trips.

Screen 16: Displays the number of phase loss trips.

Screen 17: Displays the number of tachometer acceleration trips.

Screen 18: Displays the number of undervoltage and overvoltage trips.

Screen 19: Displays the number of power factor trips.

Screen 20: Displays the number of phase reversal trips.

Screen 21: Displays the number of low control voltage trips.

Screen 22: Displays the number of external input #1 trips.

Screen 23: Displays the number of external input #2 trips.

Screen 24: Displays the number of external input #3 trips.

Screen 25: Displays the number of external input #4 trips.

Screen 26: Requires a Security Level 2 password to clear the statistics.

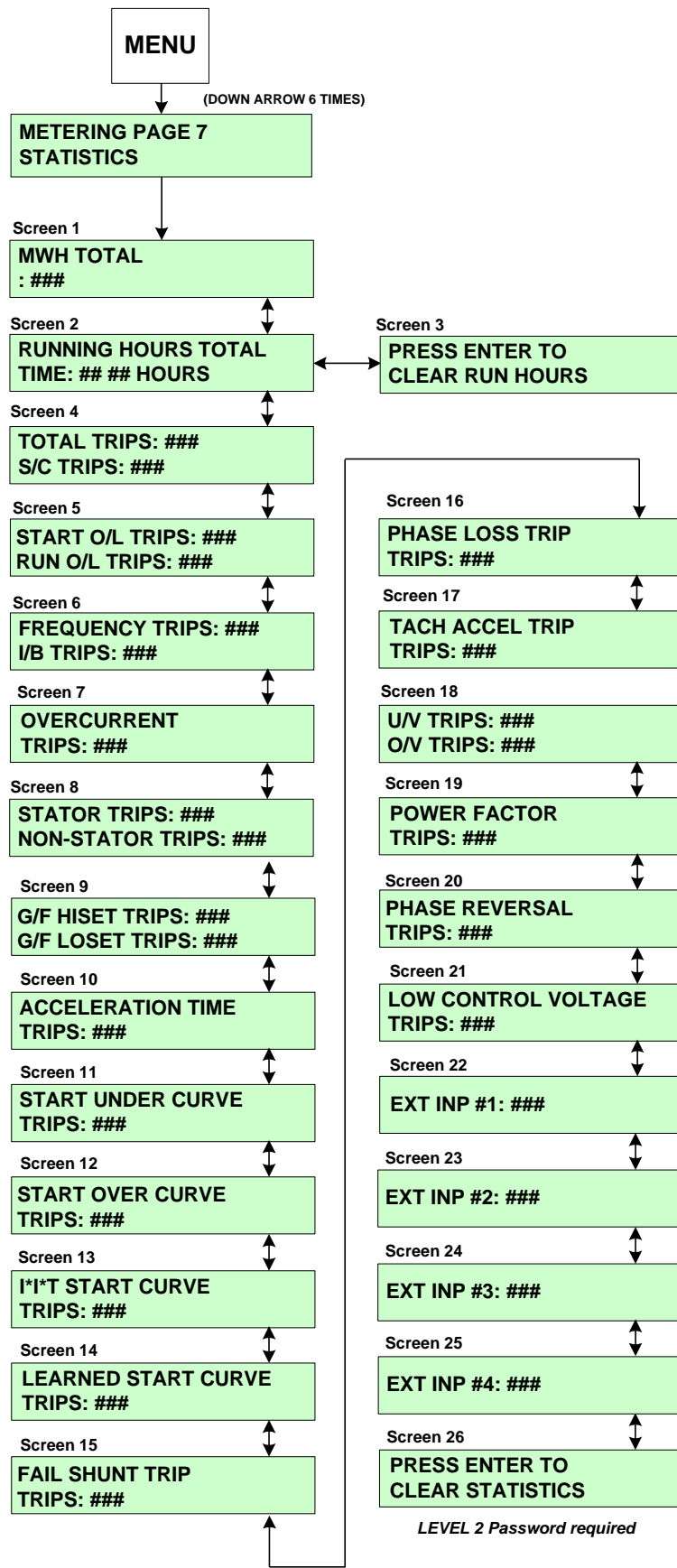

Chapter 7 - Maintenance and Troubleshooting

The Soft Starter is designed to be a maintenance-free product. However, as with all electronic equipment, the unit should be checked periodically for build-up of dirt, moisture or industrial contaminants. These can cause high voltage arc-over, carbon tracking or prevent proper cooling of the SCR heat sinks. All bolts should be checked annually for proper tightness using an accurate torque wrench. According to the manufacturer's manual, check the contactor for air gap spacing of the vacuum bottles.

Note: If the unit is installed in a contaminated environment and forced air cooling is used, blower filters must be checked and cleaned regularly to insure proper air flow and cooling of the enclosure.

7.1 Failure Analysis

When a fault occurs, the LCD will display the fault error while the listed LED and AUX Relay will be lit. Please clear all faults before attempting to restart the unit.

Note: If the problem persists after the required programming changes have been made, and all corrective action has been taken, please contact the factory for assistance.

Problem	CPU LCD Display	LED	AUX Relay	Possible Cause	Solutions
One of the main fuses blows or circuit breaker opens when the power is applied or disconnect is closed.	TCB FAULT TRIP	Trip	AUX1	Short circuit between the inputs	Locate and remove short
				Faulty SCRs	Remove power and test SCR(s). Refer to Section 7.1.1 for the SCR testing procedure
				Emergency Stop Activated	Check Emergency Stop Normally Closed Input. TB2: Terminal 9 & 10
Short Circuit Trip	SHORT CIRCUIT TRIP	Trip	AUX1	Short circuit or ground fault in motor/cabling	Locate and remove short or ground
				Phase Loss	Repair cause of phase loss
				Branch circuit protection not correctly sized	Verify correct sizing of branch circuit protection
				Faulty main circuit board	Remove power and replace main circuit board.
Single Phase Trip	SINGLE PHASE TRIP (Check LCD display for possible fault indicators)	Trip	AUX1	Single phase incoming power	Correct problem with incoming power
				Faulty SCRs	Remove power and test SCR(s). Refer to Section 7.1.1 for the SCR testing procedure
				Environment Temperature over 122° F (ambient temperature for chassis units) or over 104° F (ambient temperature for enclosed version)	Place unit in environment temperature less than 122°F for panel version or less than 104°F for enclosed version.
				Bypass failed to close	Check bypass contactor and wiring. The "At Speed" delay is incorrectly programmed. Reprogram back to factory default value.

7.1 Failure Analysis - Continued

Problem	CPU LCD Display	LED	AUX Relay	Possible Cause	Solutions
<i>Thermostat trips during run</i>	EXTERNAL TRIP ON THERMOSTAT	Trip	AUX1	Fan(s) not functioning (If supplied)	If fans have power, remove power and replace fan(s). If fans do not have power, find cause of power loss and repair.
				Heatsink coated with dirt	Remove power and clean heatsink with high pressure air (80 - 100 psi max clean and dry air).
				Overcurrent on unit	Verify that running current does not exceed unit rating.
				Environment temperature over 122° F (ambient temperature for chassis units) or over 104°F (ambient temperature for enclosed version)	Place unit in environment temperature less than 122°F for panel version or less than 104°F for enclosed version.
				Bypass failed to close	Check bypass contactor and wiring.
<i>Phase Loss</i>	PHASE LOSS	Trip	AUX1	Loss of 1 or more phases of power from utility or generated power.	Check power source.
				Blown power fuses	Check for short circuits.
<i>Overload</i>	OVERLOAD TRIP	Trip	AUX1	Improper programming	Check motor nameplate versus programmed parameters.
				Possible load damage or jammed load	Check motor currents.
<i>Stall prevention</i>	ACCEL TIME TRIP	Trip	AUX1	Improper setting for motor load condition	Verify current limit setting.
				Damaged load	Check for load failure.
<i>Under Voltage Trip</i>	UNDER VOLTAGE TRIP	Trip	AUX1	Improper programming	Check Setpoint settings.
				Wrong position of disconnect or breaker	Check disconnect or open breaker
				Main contactor failed to close	Check internal connections
				Transformer too small	Reduce current limit setting, saturation or sagging power supply transformer
				Unloaded motor	Check load
<i>Under Current Trip</i>	UNDER CURRENT TRIP	Trip	AUX1	Improper programming	Check setpoint settings
				Unloaded motor	Check load
<i>Self-test Failure</i>	SELF-TEST FAILURE	Trip	AUX1	Failed CPU or Main Firing Board	Contact factory
				Vibration	Check internal wiring connections
<i>Line Frequency Trip</i>	OVER OR UNDER FREQUENCY TRIP	Trip	AUX1	Generator Power Problem or grid change	Troubleshoot and repair generator
					Contact utility company
					Main board failure
					Three phase power removed from Main

Problem	CPU LCD Display	LED	AUX Relay	Possible Cause	Solutions
<i>Any Ground Fault Trip</i>	GROUND FAULT HI-SET OR LO-SET	Trip	AUX1	Improper programming	Check Setpoint settings
				Any wire going to ground (I.e. stator ground, motor ground, soft start ground)	Check with megger or Hi-pot motor leads and motor
				High vibration or loose connections	Check internal connections
<i>Motor Stopped during run</i>	Check for fault indication	Trip	AUX1	 WARNING This is a serious fault condition. Ensure that the fault condition is cleared on the load side before attempting to restart the motor.	
				Load shorted	Remove power and repair.
				Faulty main circuit board	Replace the main circuit board
<i>Control circuit fuses blow after control power is applied.</i>	None	None	None	Short in Control Circuit	Remove Power, locate and remove the short.
				Wrong Control Voltage	Apply the correct voltage to the control circuit.
<i>Motor will not start</i>	Any fault indication message	Trip	AUX1	No Control Voltage applied to Control Board	Apply control voltage to TCB board.
				Control Power Transformer failure or CPT Fuse failure	Remove power and replace the power transformer or the CPT fuse
				Start Circuit Wired Incorrectly	Remove power and correct the start circuit wiring.
				No Start Command	Apply the start command.
				No 3 Phase Line Voltage	Apply 3 phase line voltage to the unit.
				Shorted SCR in Starter	Remove power and Test SCR(s). Refer to Sec. 7.1.1 for the testing procedure.
				Faulty Control Logic	Remove power and repair the Control Logic.
				Failure of Main Circuit Board	Replace the Main Circuit Board.
<i>Motor vibrates / Motor growls while starting or extremely unbalanced motor currents run mode</i>	IMBALANCE TRIP	Trip	AUX1	Faulty Motor	Check the Motor and the Motor connections.
				Faulty SCR(s)	Remove Power and perform the SCR device checks.
				Faulty Gate / Cathode on SCR(s)	Remove Power and Test SCR(s). Refer to Sec. 7.1.1 for the testing procedure.
				Faulty Main Circuit Board.	Replace the Main Circuit Board.
	IMBALANCE ALARM	Alarm	AUX2	Faulty Motor / Wiring	Troubleshoot and repair / replace wiring.
				Faulty Main Circuit Board	Replace the Main Circuit Board.

7.1.1 - SCR Testing Procedure

Perform the SCR Heat Sink Ohm test on each Stack Assembly.

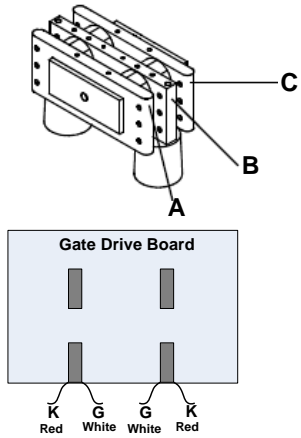

Test Points	OHM Meter Reading	Test Results
From Position A to Position B	Greater than 10K Ohm	Pass
	Less than 5K Ohm	Fail
From Position B to Position C	Greater than 10K Ohm	Pass
	Less than 5K Ohm	Fail
Gate (G) to Cathode (K) for each SCR	8 to 50 Ohms	Pass (Typical 8 to 20 Ohms)
	Less than 8 or greater than 50 Ohms	Fail

Notes

- 1 - Allow 15 minutes after shutdown for DV/DT network to discharge.
- 2 - Voltage sharing resistors may need to be disconnected to obtain correct readings for tests between positions A, B & C...

Appendix A – Modbus RTU Communication and MVC Plus Registers

The MVC Plus RS485 port allows users to connect the MVC Plus to a Modbus RTU network.

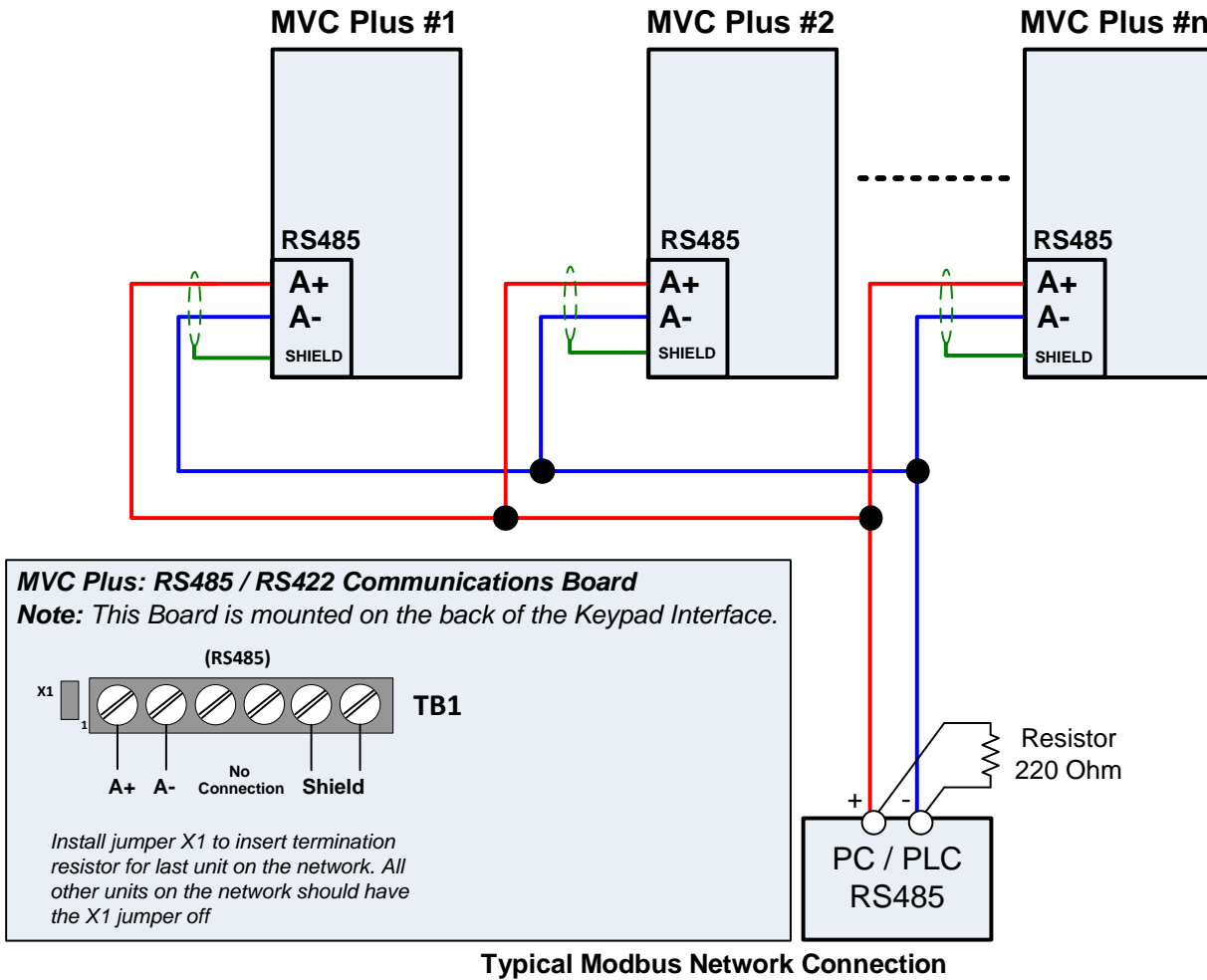

The MVC Plus supports the following Modbus functions:

Table A-1: Modbus Functions

Function Code	MVC Description	Modbus Description
3	Read Multiple Registers	Read Holding Registers
4	(same as Function code 3)	Read Input Registers
5	Execution	Force Single Coil
6	Write Single Registers	Preset Single Registers
9	Operation	-
16	Write Multiple Registers	Preset Multiple Registers

Modbus Message Frame (data format)

Function 3

- a) Query: See Table A-2: Query of Function 3 - Read Multiple Registers. In the MVC Plus the number of consecutive registers "Number of Registers" is limited to 125.
b) Response: See Table A-3: Response to Function 3 - Read Multiple Registers.

Table A-2: Query of Function 3 - Read Multiple Registers (Instance)

Field Name (byte)	Decimal	Hexadecimal
Slave Address	247	F7
Function	3	03
Starting Data Address High Byte	1001	03
Starting Data Address Low Byte		E9
Number of Registers High Byte	2	00
Number of Registers Low Byte		02
CRC Low Byte	11521	01
CRC High Byte		2D

Table A-3: Response of Function 3 - Read Multiple Registers (Instance)

Field Name (byte)	Decimal	Hexadecimal
Slave Address	247	F7
Function	3	03
Byte Count	4	04
Data High Byte of 1 st Register from Starting Data Address	10	00
Data Low Byte of 1 st Register from Starting Data Address		0A
Data High Byte of 2 nd Register from Starting Data Address	100	00
Data Low Byte of 2 nd Register from Starting Data Address		64
CRC Low Byte	54605	4D
CRC High Byte		D5

Note: The sum of Data High Bytes and Data Low Bytes equals the Byte Count.

Function 4: Same as Function 3

Function 5

a) Query: See Table A-4: Query of Function 5 - Send Access Code (Instance).

b) Response: See Table A-5: Response to Function 5 - Send Access Code (Instance).

Table A-4: Query of Function 5 and Sub Function 1 – Send Access Code (Instance)

Field Name (byte)	Decimal	Hexadecimal
Slave Address	247	F7
Function	5	05
Sub Function Low Byte	1	01
Sub Function High Byte		00
Data Low Byte	1	01
Data High Byte		00
CRC Low Byte	12505	D9
CRC High Byte		30

Table A-5: Response of Function 5 and Sub Function 1 – Send Access Code (Instance)

Field Name (byte)	Decimal	Hexadecimal
Slave Address	247	F7
Function	5	05
Sub Function Low Byte	1	01
Sub Function High Byte		00
Data Low Byte	1	01
Data High Byte		00
CRC Low Byte	12505	D9
CRC High Byte		30

Table A-6: Query of Function 5 and Sub Function 4 – Send Access Code (Instance)

Field Name (byte)	Decimal	Hexadecimal
Slave Address	247	F7
Function	5	05
Sub Function Low Byte	4	04
Sub Function High Byte		00
Data 1 Low Byte	25	19
Data 1 High Byte		00
Data 2 Low Byte	0	00
Data 2 High Byte		00
CRC Low Byte	29021	5D
CRC High Byte		71

Table A-7: Response of Function 5 and Sub Function 4 – Send Access Code (Instance)

Field Name (byte)	Decimal	Hexadecimal
Slave Address	247	F7
Function	5	05
Sub Function Low Byte	4	04
Sub Function High Byte		00
Data 1 Low Byte	25	19
Data 1 High Byte		00
Data 2 Low Byte	0	00
Data 2 High Byte		00
CRC Low Byte	29021	5D
CRC High Byte		71

Function 6

a) Query: See Table A-8: Query of Function 6 - Write Single Registers.

b) Response: See Table A-9: Response to Function 6 - Write Single Registers

Table A-8: Query of Function 6 - Write Single Register (Instance)

Field Name (byte)	Decimal	Hexadecimal
Slave Address	247	F7
Function	6	06
Starting Data Address High Byte	1001	03
Starting Data Address Low Byte		E9
Data High Byte of Register from Starting Data Address	50	00
Data Low Byte of Register from Starting Data Address		32
CRC Low Byte	52537	39
CRC High Byte		CD

Table A-9: Response of Function 6 - Write Single Register (Instance)

Field Name (byte)	Decimal	Hexadecimal
Slave Address	247	F7
Function	6	06
Starting Data Address High Byte	1001	03
Starting Data Address Low Byte		E9
Data High Byte of Register from Starting Data Address	50	00
Data Low Byte of Register from Starting Data Address		32
CRC Low Byte	52537	39
CRC High Byte		CD

Function 9

Function 9 is used for special operations in MVC plus. Function code 9 uses sub-function code 48 to represent Remote Start/Stop function. The byte following the sub-function code is the Start and Stop Control Settings byte see table A-12.

- a) Query: See Table A-10. Query of Function 9 – Reserved Operational Code.
- b) Response: See Table A-11. Response of Function 9 – Reserved Operational Code.
- c) Start and Stop Control Settings: See Table A-12. Start and Stop Control Settings.

Table A-10: Query of Function 9 – Reserved Operational Code (Instance)

Field Name (byte)	Decimal	Hexadecimal
Slave Address	247	F7
Function	9	09
Sub Function (Remote Start/Stop)	48	30
Start and Stop Control Settings	26	1A
CRC Low Byte	39287	77
CRC High Byte		99

Table A-11: Response of Function 9 - Reserved Operational Code (Instance)

Field Name (byte)	Decimal	Hexadecimal
Slave Address	247	F7
Function	9	09
Sub Function (Remote Start/Stop)	48	30
Start and Stop Control Settings	26	1A
CRC Low Byte	39287	77
CRC High Byte		99

Table A-12: Start and Stop Control Settings

Start and Stop Control Settings	Decimal	Hexadecimal
Start	26	1A
Stop	27	1B

Function 16

- c) Query: See Table A-13: Query of Function 16 - Write Multiple Registers. In the MVC Plus the number of consecutive registers "Number of Registers" is limited to 125.
- d) Response: See Table A-14: Response to Function 16 - Write Multiple Registers

Table A-13: Query of Function 16 - Write Multiple Registers (Instance)

Field Name (byte)	Decimal	Hexadecimal
Slave Address	247	F7
Function	16	10
Starting Data Address High Byte	1001	03
Starting Data Address Low Byte		E9
Number of Registers High Byte	2	00
Number of Registers Low Byte		02
Byte Count	4	04
Data High Byte of 1 st Register from Starting Data Address	15	00
Data Low Byte of 1 st Register from Starting Data Address		0F
Data High Byte of 2 nd Register from Starting Data Address	101	00
Data Low Byte of 2 nd Register from Starting Data Address		65
CRC Low Byte	57028	C4
CRC High Byte		DE

Note: The sum of Data High Bytes and Data Low Bytes equals to the Byte Count, which equal to the Number of Registers times 2.

Table A-14: Response of Function 16 - Write Multiple Registers (Instance)

Field Name (byte)	Decimal	Hexadecimal
Slave Address	247	F7
Function	16	10
Starting Data Address High Byte	1001	03
Starting Data Address Low Byte		E9
Number of Registers High Byte	2	00
Number of Registers Low Byte		02
CRC Low Byte	61060	84
CRC High Byte		EE

Exception Response Frame

In normal response, the function field will always return the function code as was used in the Query sent. If the slave device sends back an Exception response, 80 (hex) will be added to function code value to indicate an Exception response. See Table A-15: Invalid Query of Function 3 - Read Multiple Registers (Instance) and Table A-16 Response of the Invalid Function 3 Query. Also see Table A-16: Exception Codes

Table A-15: Invalid Query of Function 3 - Read Multiple Registers (Instance)

Field Name (byte)	Decimal	Hexadecimal
Slave Address	247	F7
Function	3	03
Starting Data Address High Byte	999	03
Starting Data Address Low Byte		E8
Number of Registers High Byte	1	00
Number of Registers Low Byte		01
CRC Low Byte	61216	20
CRC High Byte		EF

Table A-16: Response of the Invalid Function 3 Query

Field Name (byte)	Decimal	Hexadecimal
Slave Address	247	F7
Function	131	83
Exception Code	2	02
CRC Low Byte	15392	20
CRC High Byte		3C

Table A-17: Exception Codes

Exception Code	Name	Description
01	Illegal Function	Function code not supported.
02	Illegal Address	The register address is invalid.
03	Illegal Data Value	Invalid data received from the Rx.
06	Device Busy	The MVC Plus is busy. The master should re-transmit the message again later.
07	Negative Acknowledge	The MVC Plus cannot perform function received from the query.
16	Illegal Data Length	The field "Number of Registers" from the query exceeds 125 registers.

CRC Sequence

CRC sequence each message frame is to send the Low Byte first and High Byte second, according to the MODBUS specification. However, to communication with the RS232 Front Port, the CRC sequence has to be reversed in all the query and response frames, High Byte first and Low Byte second.

Table A-18: MVC Plus Registers ordered by Modbus Address

MODBUS REGISTER MAP							
Setpoint Page #	Register Address	Register Name	Data				Remark
			Min	Max	Inc	Default	
Setpoint Page 1	1000	2 ND FLA	1	2000	1	100	Only for 2-speed f/w
	1001	FLA	1	2000	1	100	
	1002	SF	100	130	1	115	=> 1.0-1.30
	1003	NEMA Design	0	5	1	1	
	1004	Overload Class	5	30	5	10	
	1005	Insulation Class	0	8	1	4	
	1006	Line Voltage	100	20000	1	4160	
	1007	Line Frequency	50	60	10	60	
Setpoint Page 2	1020	Starter Mode	0	6	1	2	
	1021	Jog Voltage	5	75	5	30	
	1022	Start Ramp 1 Type	1	2	1	1	
	1023	Voltage Ramp 1 Initial Voltage	0	100	1	20	
	1024	Voltage Ramp 1 Ramp Time	1	120	1	10	
	1025	Voltage Ramp 1 Current Limit	200	500	10	350	
	1026	Current Ramp 1 Initial Current	0	300	1	200	
	1027	Current Ramp 1 Ramp Time	1	120	1	10	
	1028	Current Ramp 1 Maximum Current	200	500	10	350	
	1034	Start Ramp 2 Type	0	2	1	0	Type changed since v6.5
	1035	Voltage Ramp 2 Initial Voltage	0	100	1	60	
	1036	Voltage Ramp 2 Ramp Time	1	120	1	10	
	1037	Voltage Ramp 2 Current Limit	200	500	10	350	
	1038	Power Ramp 2 Initial Current	0	100	1	20	
	1039	Power Ramp 2 Ramp Time	1	120	1	10	
	1040	Power Ramp 2 Maximum	0	300	10	80	
	1046	Kick Start Enable	0	1	1	0	
	1047	Kick Start Voltage	10	100	5	65	
	1048	Kick Start Voltage Time	10	200	10	50	
	1049	Kick Start Current	200	500	10	200	
	1050	Kick Start Current Time	10	200	10	50	
	1051	Decel Enable	0	1	1	0	
	1052	Decel Start Voltage	10	100	1	100	
	1053	Decel Stop Voltage	0	100	1	30	
	1054	Decel Time	1	60	1	5	
	1055	Reserved					
	1056	Timed Output Time	1	1000, 0xffff	1	OFF	0xffff =>OFF; OFF => 0xffff.
1057	Run Delay Time	1	30, 0xffff	1	1		
1058	At Speed Delay Time	1	30, 0xffff	1	1		
1059	Bypass Pull-in Current	90	300	1	100		
Setpoint Page 3	1082	Imbalance Alarm Level	5	30, 0xffff	1	15	
	1083	Imbalance Alarm Delay	10	200	1	15	
	1084	Imbalance Trip Level	5	30, 0xffff	1	20	
	1085	Imbalance Trip Delay	10	200	1	20	
	1086	Under Current Level	10	90, 0xffff	1	OFF	
	1087	Under Current Delay	10	600	1	20	
	1088	Over Current Alarm Level	100	300, 0xffff	1	OFF	
	1089	Over Current Alarm Delay	10	200	1	20	

	1090	Over Current Trip Level	100	300, 0xffff	1	OFF	
	1091	Over Current Trip Delay	10	200	1	20	
	1092	Phase Loss Trip	0	1	1	1	0: Disabled; 1: Enabled
	1093	Phase Loss Trip Delay	0	200	1	1	
	1094	Phase Rotation Detection	0	2	1	1	0: Dis 1: ABC 2: ACB
	1095	Phase Rotation Trip Delay	10	200	1	10	
	1096	GF Alarm Level	5	90, 0xffff	1	OFF	
	1097	GF Alarm Delay	1	200	1	1	
	1098	GF Trip LoSet Level	5	90, 0xffff	1	OFF	
	1099	GF LoSet Delay	1	200	1	200	
	1100	GF Trip HiSet Level	5	90, 0xffff	1	OFF	
	1101	GF HiSet Delay	8	250	2	250	
	1102	Over Voltage Alarm Level	5	30, 0xffff	1	OFF	
	1103	Over Voltage Alarm Delay	10	300	1	10	
	1104	Over Voltage Trip Level	5	30, 0xffff	1	10	
	1105	Over Voltage Trip Delay	10	300	1	20	
	1106	Under Voltage Alarm Level	5	30, 0xffff	1	OFF	
	1107	Under Voltage Alarm Delay	10	300	1	10	
	1108	Under Voltage Trip Level	5	30, 0xffff	1	15	
	1109	Under Voltage Trip Delay	10	300	1	20	
	1110	Line Frequency Trip Window	0	6, 0xffff	1	OFF	
	1111	Line Frequency Trip Delay	10	200	1	10	
	1112	Power Factor Lead Alarm	1	100, 0xffff	1	OFF	
	1113	Power Factor Lead Alarm Delay	1	120	1	1	
	1114	Power Factor Lead Trip	1	100, 0xffff	1	OFF	
	1115	Power Factor Lead Trip Delay	1	120	1	1	
	1116	Power Factor Lag Alarm	1	100, 0xffff	1	OFF	
	1117	Power Factor Lag Alarm Delay	1	120	1	1	
	1118	Power Factor Lag Trip	1	100, 0xffff	1	OFF	
	1119	Power Factor Lag Trip Delay	1	120	1	1	
	1120	Reserved					
	1121	Reserved					
	1122	Power Demand Period	1	60	1	10	
	1123	KW Demand Alarm Pickup Low Byte	1	100000, 0xffffffff	1	OFF	
	1124	KW Demand Alarm Pickup High Byte					
	1125	KVA Demand Alarm Pickup Low Byte	1	100000, 0xffffffff	1	OFF	
	1126	KVA Demand Alarm Pickup High Byte					
	1127	KVAR Demand Alarm Pickup Low Byte	1	100000, 0xffffffff	1	OFF	
	1128	KVAR Demand Alarm Pickup High Byte					
	1129	AMPS Demand Alarm Pickup Low Byte	1	100000, 0xffffffff	1	OFF	
	1130	AMPS Demand Alarm Pickup High Byte					
Setpoint Page 4	1250	O/L Trip First	1	1	1	1	Trip Only
	1251	O/L Trip Second	5	9	1	9	
	1252	O/L Trip Third	5	9	1	9	
	1253	I/B Trip First	0	8	1	1	
	1254	I/B Trip Second	5	9	1	9	
	1255	I/B Trip Third	5	9	1	9	
	1256	S/C Trip First	1	1	1	1	Trip Only
	1257	S/C Trip Second	5	9	1	9	
	1258	S/C Trip Third	5	9	1	9	
	1259	Over Current Trip First	0	8	1	1	
	1260	Over Current Trip Second	5	9	1	9	
	1261	Over Current Trip Third	5	9	1	9	
	1262	Stator Trip First	0	8	1	0	
	1263	Stator Trip Second	5	9	1	9	

1264	Stator Trip Third	5	9	1	9	
1265	Non-Stator Trip First	0	8	1	0	
1266	Non-Stator Trip Second	5	9	1	9	
1267	Non-Stator Trip Third	5	9	1	9	
1268	G/F Hi Set Trip First	0	8	1	1	
1269	G/F Hi Set Trip Second	5	9	1	9	
1270	G/F Hi Set Trip Third	5	9	1	9	
1271	G/F Lo Set Trip First	0	8	1	1	
1272	G/F Lo Set Trip Second	5	9	1	9	
1273	G/F Lo Set Trip Third	5	9	1	9	
1274	Phase Reversal First	0	8	1	2	
1275	Phase Reversal Second	5	9	1	9	
1276	Phase Reversal Third	5	9	1	9	
1277	Phase Loss Trip First	0	8	1	1	
1278	Phase Loss Trip Second	5	9	1	9	
1279	Phase Loss Trip Third	5	9	1	9	
1280	Accel Time First	1	1	1	1	Trip Only
1281	Accel Time Second	5	9	1	9	
1282	Accel Time Third	5	9	1	9	
1283	Start Curve Trip First	1	1	1	1	Trip Only
1284	Start Curve Trip Second	5	9	1	9	
1285	Start Curve Trip Third	5	9	1	9	
1286	Start Curve I*I*T First	0	8	1	1	
1287	Start Curve I*I*T Second	5	9	1	9	
1288	Start Curve I*I*T Third	5	9	1	9	
1289	Start Curve Over First	0	8	1	1	
1290	Start Curve Over Second	5	9	1	9	
1291	Start Curve Over Third	5	9	1	9	
1292	Over Frequency Trip First	0	8	1	1	
1293	Over Frequency Trip Second	5	9	1	9	
1294	Over Frequency Trip Third	5	9	1	9	
1295	Under Frequency Trip First	0	8	1	1	
1296	Under Frequency Trip Second	5	9	1	9	
1297	Under Frequency Trip Third	5	9	1	9	
1298	Tach Accel Trip First	0	8	1	0	
1299	Tach Accel Trip Second	5	9	1	9	
1300	Tach Accel Trip Third	5	9	1	9	
1301	Inhibits Trip First	0	8	1	2	
1302	Inhibits Trip Second	5	9	1	9	
1303	Inhibits Trip Third	5	9	1	9	
1304	O/L Warning First	0	8	1	2	
1305	O/L Warning Second	5	9	1	9	
1306	O/L Warning Third	5	9	1	9	
1307	Over Current Alarm First	0	8	1	2	
1308	Over Current Alarm Second	5	9	1	9	
1309	Over Current Alarm Third	5	9	1	9	
1310	Shunt Trip First	0	8	1	1	
1311	Shunt Trip Second	5	9	1	9	
1312	Shunt Trip Third	5	9	1	9	
1313	Ground Fault Alarm First	0	8	1	2	
1314	Ground Fault Alarm Second	5	9	1	9	
1315	Ground Fault Alarm Third	5	9	1	9	
1316	Under Current First	0	8	1	0	
1317	Under Current Second	5	9	1	9	
1318	Under Current Third	5	9	1	9	
1319	I/B Alarm First	0	8	1	2	
1320	I/B Alarm Second	5	9	1	9	
1321	I/B Alarm Third	5	9	1	9	
1322	Stator Rtd Alarm First	0	8	1	0	

1323	Stator Rtd Alarm Second	5	9	1	9
1324	Stator Rtd Alarm Third	5	9	1	9
1325	Non-Stator Rtd Alarm First	0	8	1	0
1326	Non-Stator Rtd Alarm Second	5	9	1	9
1327	Non-Stator Rtd Alarm Third	5	9	1	9
1328	Rtd Failure Alarm First	0	8	1	0
1329	Rtd Failure Alarm Second	5	9	1	9
1330	Rtd Failure Alarm Third	5	9	1	9
1331	Self Test Fail First	0	8	1	1
1332	Self Test Fail Second	5	9	1	9
1333	Self Test Fail Third	5	9	1	9
1334	Thermal Register Alarm First	0	8	1	2
1335	Thermal Register Alarm Second	5	9	1	9
1336	Thermal Register Alarm Third	5	9	1	9
1337	Motor Running First	0	8	1	3
1338	Motor Running Second	5	9	1	9
1339	Motor Running Third	5	9	1	9
1340	Run Delay Time First	0	8	1	0
1341	Run Delay Time Second	5	9	1	9
1342	Run Delay Time Third	5	9	1	9
1343	Timed Output First	0	8	1	0
1344	Timed Output Second	5	9	1	9
1345	Timed Output Third	5	9	1	9
1346	At Speed First	0	8	1	4
1347	At Speed Second	5	9	1	9
1348	At Speed Third	5	9	1	9
1349	External Input #1 First	0	8	1	1
1350	External Input #1 Second	5	9	1	9
1351	External Input #1 Third	5	9	1	9
1352	External Input #2 First	0	8	1	1
1353	External Input #2 Second	5	9	1	9
1354	External Input #2 Third	5	9	1	9
1355	External Input #3 First	0	8	1	0
1356	External Input #3 Second	5	9	1	9
1357	External Input #3 Third	5	9	1	9
1358	External Input #4 First	0	8	1	1
1359	External Input #4 Second	5	9	1	9
1360	External Input #4 Third	5	9	1	9
1361	Power Factor Alarm First	0	8	1	0
1362	Power Factor Alarm Second	5	9	1	9
1363	Power Factor Alarm Third	5	9	1	9
1364	UV Alarm First	0	8	1	2
1365	UV Alarm Second	5	9	1	9
1366	UV Alarm Third	5	9	1	9
1367	OV Alarm First	0	8	1	2
1368	OV Alarm Second	5	9	1	9
1369	OV Alarm Third	5	9	1	9
1370	UV Trip First	0	8	1	1
1371	UV Trip Second	5	9	1	9
1372	UV Trip Third	5	9	1	9
1373	OV Trip First	0	8	1	1
1374	OV Trip Second	5	9	1	9
1375	OV Trip Third	5	9	1	9
1376	Power Factor Trip First	0	8	1	0
1377	Power Factor Trip Second	5	9	1	9
1378	Power Factor Trip Third	5	9	1	9
1379	KW Alarm First	0	8	1	0
1380	KW Alarm Second	5	9	1	9
1381	KW Alarm Third	5	9	1	9

	1382	KVA Alarm First	0	8	1	0	
	1383	KVA Alarm Second	5	9	1	9	
	1384	KVA Alarm Third	5	9	1	9	
	1385	KVAR Alarm First	0	8	1	0	
	1386	KVAR Alarm Second	5	9	1	9	
	1387	KVAR Alarm Third	5	9	1	9	
	1388	AMPS Alarm First	0	8	1	0	
	1389	AMPS Alarm Second	5	9	1	9	
	1390	AMPS Alarm Third	5	9	1	9	
	1391	Bypass Discrepancy First	1	1	1	1	Trip Only
	1392	Bypass Discrepancy Second	5	9	1	9	
	1393	Bypass Discrepancy Third	5	9	1	9	
	1394	Low Control Voltage (Trip) First	1	1	1	1	Trip Only
	1395	Low Control Voltage (Trip) Second	5	9	1	9	
	1396	Low Control Voltage (Trip) Third	5	9	1	9	
Setpoint Page 5	1400	Trip (Aux1) Relay Fail-Safe	0	1	1	0	
	1401	Alarm (Aux2) Relay Fail-Safe	0	1	1	0	
	1402	Aux3 Relay Fail-Safe	0	1	1	0	
	1403	Aux4 Relay Fail-Safe	0	1	1	0	
	1404	Aux5 Relay Fail-Safe	0	1	1	0	
	1405	Aux6 Relay Fail-Safe	0	1	1	0	
	1406	Aux7 Relay Fail-Safe	0	1	1	0	
	1407	Aux8 Relay Fail-Safe	0	1	1	0	
	1408	Trip (Aux1) Relay Latched	0	1	1	1	
	1409	Alarm (Aux2) Relay Latched	0	1	1	0	
	1410	Aux3 Relay Latched	0	1	1	0	
	1411	Aux4 Relay Latched	0	0	1	0	
	1412	Aux5 Relay Latched	0	1	1	0	
	1413	Aux6 Relay Latched	0	1	1	0	
	1414	Aux7 Relay Latched	0	1	1	0	
	1415	Aux8 Relay Latched	0	1	1	0	
Setpoint Page 6	1500	Tach Ramp Time	1	120	1	10	
	1501	Tachometer Scale Selection	0	1	1	0	0/1:dis/en
	1502	Manual Tach Scale 4ma	0	3600	1	0	
	1503	Manual Tach Scale 20ma	0	3600	1	2000	
	1504	Tach Accel Trip Mode Select	0	2	1	0	0: dis 1: under 2: over
	1505	Tach Underspeed Trip Pt	0	3600	1	1650	
	1506	Tach Overspeed Trip Pt	0	3600	1	1850	
	1507	Tach Accel Trip Delay	1	60	1	1	
	1508	Analog Output #1 Select	0	6	1	4	
	1509	Analog Output #1 4ma	0	32767	1	0	
	1510	Analog Output #1 20ma	0	32767	1	250	
	1511	Analog Output #2 Select	0	6	1	5	
	1512	Analog Output #2 4ma	0	32767	1	0	
	1513	Analog Output #2 20ma	0	32767	1	1000	
	1848	External Input #1 Select	0	1	1	1	
	1849	External Input #1 Type	0	1	1	0	
	1850	External Input #1 Time Delay	0	60	1	1	
	1851	External Input #1 Name (Char2, Char1)				C,T	String
	1852	External Input #1 Name (Char4, Char3)				,B	-
	1853	External Input #1 Name (Char6, Char5)				A,F	-
	1854	External Input #1 Name (Char8, Char7)				L,U	-
	1855	External Input #1 Name (Char10, Char9)				,T	-
	1856	External Input #1 Name (Char12, Char11)					-

	1857	External Input #1 Name (Char14, Char13)						-
	1858	External Input #1 Name (n/a , Char15)						-
	1859	External Input #2 Select	0	1	1	1		For 2-speed f/w, range and default are 2.
	1860	External Input #2 Type	0	1	1	0		
	1861	External Input #2 Time Delay	0	60	1	1		
	1862	External Input #2 Name (Char2, Char1)						String
	1863	External Input #2 Name (Char4, Char3)						-
	1864	External Input #2 Name (Char6, Char5)						-
	1865	External Input #2 Name (Char8, Char7)						-
	1866	External Input #2 Name (Char10, Char9)						-
	1867	External Input #2 Name (Char12, Char11)						-
	1868	External Input #2 Name (Char14, Char13)						-
	1869	External Input #2 Name (n/a , Char15)						-
	1870	External Input #3 Select	0	2	1	2		
	1871	External Input #3 Type	0	1	1	0		
	1872	External Input #3 Time Delay	0	60	1	0		
	1873	External Input #3 Name (Char2, Char1)					U,D	String
	1874	External Input #3 Name (Char4, Char3)					L,A	-
	1875	External Input #3 Name (Char6, Char5)					R,	-
	1876	External Input #3 Name (Char8, Char7)					M,A	-
	1877	External Input #3 Name (Char10, Char9)					,P	-
	1878	External Input #3 Name (Char12, Char11)						-
	1879	External Input #3 Name (Char14, Char13)						-
	1880	External Input #3 Name (n/a , Char15)						-
	1881	External Input #4 Select	0	2	1	1		
	1882	External Input #4 Type	0	1	1	1		
	1883	External Input #4 Time Delay	0	60	1	1		
	1884	External Input #4 Name (Char2, Char1)					H,T	String
	1885	External Input #4 Name (Char4, Char3)					R,E	-
	1886	External Input #4 Name (Char6, Char5)					A,M	-
	1887	External Input #4 Name (Char8, Char7)					S,L	-
	1888	External Input #4 Name (Char10, Char9)					A,T	-
	1889	External Input #4 Name (Char12, Char11)					,T	-
	1890	External Input #4 Name (Char14, Char13)						-
	1891	External Input #4 Name (n/a , Char15)						-
Setpoint Page 7	1530	Custom Accel Curve	0	3	1	0		
	1531	Curve A Current Limit	200	500	10	350		
	1532	Curve A Voltage Level 1	0	100	1	25		
	1533	Curve A Ramp Time 1	1	60	1	2		
	1534	Curve A Voltage Level 2	0	100	1	30		
	1535	Curve A Ramp Time 2	1	60	1	2		
	1536	Curve A Voltage Level 3	0	100	1	37		
	1537	Curve A Ramp Time 3	1	60	1	2		
	1538	Curve A Voltage Level 4	0	100	1	45		
	1539	Curve A Ramp Time 4	1	60	1	2		
	1540	Curve A Voltage Level 5	0	100	1	55		
	1541	Curve A Ramp Time 5	1	60	1	2		
	1542	Curve A Voltage Level 6	0	100	1	67		
	1543	Curve A Ramp Time 6	1	60	1	2		
	1544	Curve A Voltage Level 7	0	100	1	82		

	1545	Curve A Ramp Time 7	1	60	1	2
	1546	Curve A Voltage Level 8	0	100	1	100
	1547	Curve A Ramp Time 8	1	60	1	2
	1548	Curve B Current Limit	200	500	10	350
	1549	Curve B Voltage Level 1	0	100	1	25
	1550	Curve B Ramp Time 1	1	60	1	2
	1551	Curve B Voltage Level 2	0	100	1	30
	1552	Curve B Ramp Time 2	1	60	1	2
	1553	Curve B Voltage Level 3	0	100	1	37
	1554	Curve B Ramp Time 3	1	60	1	2
	1555	Curve B Voltage Level 4	0	100	1	45
	1556	Curve B Ramp Time 4	1	60	1	2
	1557	Curve B Voltage Level 5	0	100	1	55
	1558	Curve B Ramp Time 5	1	60	1	2
	1559	Curve B Voltage Level 6	0	100	1	67
	1560	Curve B Ramp Time 6	1	60	1	2
	1561	Curve B Voltage Level 7	0	100	1	82
	1562	Curve B Ramp Time 7	1	60	1	2
	1563	Curve B Voltage Level 8	0	100	1	100
	1564	Curve B Ramp Time 8	1	60	1	2
	1565	Curve C Current Limit	200	500	10	350
	1566	Curve C Voltage Level 1	0	100	1	25
	1567	Curve C Ramp Time 1	1	60	1	2
	1568	Curve C Voltage Level 2	0	100	1	30
	1569	Curve C Ramp Time 2	1	60	1	2
	1570	Curve C Voltage Level 3	0	100	1	37
	1571	Curve C Ramp Time 3	1	60	1	2
	1572	Curve C Voltage Level 4	0	100	1	45
	1573	Curve C Ramp Time 4	1	60	1	2
	1574	Curve C Voltage Level 5	0	100	1	55
	1575	Curve C Ramp Time 5	1	60	1	2
	1576	Curve C Voltage Level 6	0	100	1	67
	1577	Curve C Ramp Time 6	1	60	1	2
	1578	Curve C Voltage Level 7	0	100	1	82
	1579	Curve C Ramp Time 7	1	60	1	2
	1580	Curve C Voltage Level 8	0	100	1	100
	1581	Curve C Ramp Time 8	1	60	1	2
Setpoint Page 8	1600	Run Curve Locked Rotor Time	1	30, 0xffff	1	O/L CLASS
	1601	Run Lock Rotor Current	400	800	1	600
	1602	Start Curve Locked Rotor Time	1	30, 0xffff	1	O/L CLASS
	1603	Start Lock Rotor Current	400	800	10	600
	1604	Area Under Curve Protection	0	1	1	0
	1605	Maximum I*T Start	1	2500	1	368
	1606	Current Over Curve	0	2	1	0
	1607	Learned Start Start Curve Bias	5	40	1	10
	1608	Time For Sampling	1	300	1	30
	1609	Accel Time Limit	1	300, 0xffff	1	30
	1610	Coast Down Timer Time	1	60, 0xffff	1	DISABLED
	1611	Number of Starts Per Hour	1	6, 0xffff	1	DISABLED
	1612	Time Between Starts Time	1	60, 0xffff	1	DISABLED
	1613	Reserved				

1620	Use Nema Temp For Rtd Values	0	1	1	0	
1621	# of Rtd's Used For Stator	0	6	1	6	
1622	Rtd Voting	0	1	1	0	
1623	Rtd #1 Description Reg0					String
1624	Rtd #1 Description Reg1					-
1625	Rtd #1 Description Reg2					-
1626	Rtd #1 Description Reg3					-
1627	Rtd #1 Description Reg4					-
1628	Rtd #1 Description Reg5					-
1629	Rtd #1 Description Reg6					-
1630	Rtd #1 Description Reg7					-
1631	Stator Phase A1 Type	0	4	1	0	
1632	Stator Phase A1 Alarm Level	0	240, 0xffff	1	OFF	
1633	Stator Phase A1 Trip Level	0	240, 0xffff	1	OFF	
1634	Reserved					
1635	Reserved					
1636	Reserved					
1637	Rtd #2 Description Reg0					String
1638	Rtd #2 Description Reg1					-
1639	Rtd #2 Description Reg2					-
1640	Rtd #2 Description Reg3					-
1641	Rtd #2 Description Reg4					-
1642	Rtd #2 Description Reg5					-
1643	Rtd #2 Description Reg6					-
1644	Rtd #2 Description Reg7					-
1645	Stator Phase A2 Type	0	4	1	0	
1646	Stator Phase A2 Alarm Level	0	240, 0xffff	1	OFF	
1647	Stator Phase A2 Trip Level	0	240, 0xffff	1	OFF	
1648	Reserved					
1649	Reserved					
1650	Reserved					
1651	Rtd #3 Description Reg0					String
1652	Rtd #3 Description Reg1					-
1653	Rtd #3 Description Reg2					-
1654	Rtd #3 Description Reg3					-
1655	Rtd #3 Description Reg4					-
1656	Rtd #3 Description Reg5					-
1657	Rtd #3 Description Reg6					-
1658	Rtd #3 Description Reg7					-
1659	Stator Phase B1 Type	0	4	1	0	
1660	Stator Phase B1 Alarm Level	0	240, 0xffff	1	OFF	
1661	Stator Phase B1 Trip Level	0	240, 0xffff	1	OFF	
1662	Reserved					
1663	Reserved					
1664	Reserved					
1665	Rtd #4 Description Reg0					String
1666	Rtd #4 Description Reg1					-
1667	Rtd #4 Description Reg2					-
1668	Rtd #4 Description Reg3					-
1669	Rtd #4 Description Reg4					-
1670	Rtd #4 Description Reg5					-
1671	Rtd #4 Description Reg6					-
1672	Rtd #4 Description Reg7					-
1673	Stator Phase B2 Type	0	4	1	0	
1674	Stator Phase B2 Alarm Level	0	240, 0xffff	1	OFF	
1675	Stator Phase B2 Trip Level	0	240, 0xffff	1	OFF	
1676	Reserved					
1677	Reserved					
1678	Reserved					

1679	Rtd #5 Description Reg0					String
1680	Rtd #5 Description Reg1					-
1681	Rtd #5 Description Reg2					-
1682	Rtd #5 Description Reg3					-
1683	Rtd #5 Description Reg4					-
1684	Rtd #5 Description Reg5					-
1685	Rtd #5 Description Reg6					-
1686	Rtd #5 Description Reg7					-
1687	Stator Phase C1 Type	0	4	1	0	
1688	Stator Phase C1 Alarm Level	0	240, 0xffff	1	OFF	
1689	Stator Phase C1 Trip Level	0	240, 0xffff	1	OFF	
1690	Reserved					
1691	Reserved					
1692	Reserved					
1693	Rtd #6 Description Reg0					String
1694	Rtd #6 Description Reg1					-
1695	Rtd #6 Description Reg2					-
1696	Rtd #6 Description Reg3					-
1697	Rtd #6 Description Reg4					-
1698	Rtd #6 Description Reg5					-
1699	Rtd #6 Description Reg6					-
1700	Rtd #6 Description Reg7					-
1701	Stator Phase C2 Type	0	4	1	0	
1702	Stator Phase C2 Alarm Level	0	240, 0xffff	1	OFF	
1703	Stator Phase C2 Trip Level	0	240, 0xffff	1	OFF	
1704	Reserved					
1705	Reserved					
1706	Reserved					
1707	Rtd #7 Description Reg0					String
1708	Rtd #7 Description Reg1					-
1709	Rtd #7 Description Reg2					-
1710	Rtd #7 Description Reg3					-
1711	Rtd #7 Description Reg4					-
1712	Rtd #7 Description Reg5					-
1713	Rtd #7 Description Reg6					-
1714	Rtd #7 Description Reg7					-
1715	End Bearing Type	0	4	1	0	
1716	End Bearing Alarm Level	0	240, 0xffff	1	OFF	
1717	End Bearing Trip Level	0	240, 0xffff	1	OFF	
1718	Reserved					
1721	Reserved					
1720	Reserved					
1721	Rtd #8 Description Reg0					String
1722	Rtd #8 Description Reg1					-
1723	Rtd #8 Description Reg2					-
1724	Rtd #8 Description Reg3					-
1725	Rtd #8 Description Reg4					-
1726	Rtd #8 Description Reg5					-
1727	Rtd #8 Description Reg6					-
1728	Rtd #8 Description Reg7					-
1729	Shaft Bearing Type	0	4	1	0	
1730	Shaft Bearing Alarm Level	0	240, 0xffff	1	OFF	
1731	Shaft Bearing Trip Level	0	240, 0xffff	1	OFF	
1732	Reserved					
1733	Reserved					
1734	Reserved					
1735	Rtd #9 Description Reg0					String
1736	Rtd #9 Description Reg1					-
1737	Rtd #9 Description Reg2					-

1738	Rtd #9 Description Reg3					-
1739	Rtd #9 Description Reg4					-
1740	Rtd #9 Description Reg5					-
1741	Rtd #9 Description Reg6					-
1742	Rtd #9 Description Reg7					-
1743	Rtd #9 Type	0	4	1	0	
1744	Rtd #9 Alarm Level	0	240, 0xffff	1	OFF	
1745	Rtd #9 Trip Level	0	240, 0xffff	1	OFF	
1746	Reserved					
1747	Reserved					
1748	Reserved					
1749	Rtd #10 Description Reg0					String
1750	Rtd #10 Description Reg1					-
1751	Rtd #10 Description Reg2					-
1752	Rtd #10 Description Reg3					-
1753	Rtd #10 Description Reg4					-
1754	Rtd #10 Description Reg5					-
1755	Rtd #10 Description Reg6					-
1756	Rtd #10 Description Reg7					-
1757	Rtd #10 Type	0	4	1	0	
1758	Rtd #10 Alarm Level	0	240, 0xffff	1	OFF	
1759	Rtd #10 Trip Level	0	240, 0xffff	1	OFF	
1760	Reserved					
1761	Reserved					
1762	Reserved					
1763	Rtd #11 Description Reg0					String
1764	Rtd #11 Description Reg1					-
1765	Rtd #11 Description Reg2					-
1766	Rtd #11 Description Reg3					-
1767	Rtd #11 Description Reg4					-
1768	Rtd #11 Description Reg5					-
1769	Rtd #11 Description Reg6					-
1770	Rtd #11 Description Reg7					-
1771	Rtd #11 Type	0	4	1	0	
1772	Rtd #11 Alarm Level	0	240, 0xffff	1	OFF	
1773	Rtd #11 Trip Level	0	240, 0xffff	1	OFF	
1774	Reserved					
1775	Reserved					
1776	Reserved					
1777	Rtd #12 Description Reg0					String
1778	Rtd #12 Description Reg1					-
1779	Rtd #12 Description Reg2					-
1780	Rtd #12 Description Reg3					-
1781	Rtd #12 Description Reg4					-
1782	Rtd #12 Description Reg5					-
1783	Rtd #12 Description Reg6					-
1784	Rtd #12 Description Reg7					-
1785	Rtd #12 Type	0	4	1	0	
1786	Rtd #12 Alarm Level	0	240, 0xffff	1	OFF	
1787	Rtd #12 Trip Level	0	240, 0xffff	1	OFF	
1788~ 1790	Reserved					
1120	RTD Trip Delay	1	60	1	10	
1121	RTD Alarm Delay	1	60	1	5	
Setpoint Page 10	1800	Metering Password	0	999	1	123
	1801	Level 2 Password	100	999	1	100
	1802	Level 3 Password	1000	9999	1	1000
	1803	Factory Password Low Byte	10000	99999	1	48562
	1804	Factory Password High Byte				

Setpoint Page 11	1810	Modbus Address Number	1	247	1	247	
	1811	Set Access Code	1	999	1	1	1-993: Access all functions; 994: Only access Fn3; 995: Access Fn3,5 and 16; 996: Access Fn3,5,6 and 16; 997: Access Fn3,4,5,6 and 16; 998: Access Fn3,4,5,6,9, 16; 999: For factory use.
	1812	Set Front Baud Rate	1	7	1	3	
	1813	Set Modbus Baud Rate	1	6	1	3	
	1814	Reserved					
	1815	Set Link Baud Rate	1	7	1	5	
	1816	Remote Start/Stop	0	1	1	0	
	1817	Reserved					
Setpoint Page 12	1830	Metering Date Page #	1	4	1	1	
	1831	Metering Data Screen #	1	40	1	1	
	1832	RTD Failure Alarm	0	1	1	0	
	1833	Thermal Register Min	10	50, 0xffff	1	15	
	1834	Thermal Register Alarm	40	95, 0xffff	1	90	
	1835	Thermal Alarm Delay	1	20	1	10	
	1836	Stopped Cool Down Time	10	300	1	30	
	1837	Run Cool Down Time	10	300	1	15	
	1838	Hot Stall Time	4	40, 0xffff	1	½ O/L CLASS	
	1839	Cold Stall Time	4	40, 0xffff	1	O/L CLASS	
	1840	Relay Measured Cool Rates	0	1	1	0	
	1841	Motor Design Ambient temperature	10	90	1	40	
	1842	Motor Design Run Temperature	50	100	1	80	
	1843	Motor Stator Max Temperature	10	240, 0xffff	1	INS CLS	
	1844	I/B Input To Thermal Register	0	1	1	0	
	1845	Use Calculated K Or Assign	1	50, 0xffff	1	7	
1846	Reserved						

Metering Page #	Register Address	Register Name	Data				Remark
			Data Type	Scale	Unit	Example	
Metering Page 1	2000	IA (RMS IphaseA)	UI	x1	Amps		UI: Unsigned Integer Note: Don't show scale later if it is x1.
	2001	IB (RMS IphaseB)	UI		Amps		
	2002	IC (RMS IphaseC)	UI		Amps		
	2003	G/F (RMS IGFault)	UI	x0.01	Amps		
	2004	Vab (RMS Vab)	UI		Volts		In page 2.
	2005	Vbc (RMS Vbc)	UI		Volts		In page 2.
	2006	Vca (RMS Vca)	UI		Volts		In page 2.
	2007	I(avg) RMS Iavg	UI		Amps		
	2008	RMS Vavg	UI		Amps		In page 2.
	2009	Motor Load % of FLA	UI		%		
	2010	G/F (RMS IGFault)	UI		Amps		
	2011	Thermal Register Remaining	IN		%		IN: Integer
	2012	Thermal Register to Start	IN		%		
	2013	I/B (Current ImBalance)	IN		%		
	2014	Reserved	IN		-		
	2015	I*I*T to Start	UI		Amp*Amp*Sec		See Reg Addr 1605
	2016	Average Start Time	UI		Sec		
	2017	Last Start Time	UI		Sec		
	2018	Average Start Current	UI		Amps		
	2019	Reserved	UI				
	2020	Line Frequency	UI		Hz		
	2021	Power Factor	IN	x0.01	-		In page 2.
	2022	RPM	IN		Rpm		
2023	Phase Order	UI		-		0=Unknown, 1=ABC, 2=ACB	
Metering Page 2	2800	Reserved	UI		-		
	2801	Power Factor Sign	UI		-		0: Lead; 1: Lag
	2802	Power Factor	IN	x0.01	-		
	2803	KWH Used	IN		Kwh		
	2804-5	KW	UNS32		Kw		1 st reg: LSW; 2 nd reg: MSW. LSW: Least Significant Word; MSW: Most Significant Word;
	2806-7	KVA	UNS32		Kw		1 st reg: LSW; 2 nd reg: MSW.
	2808-9	KVAR	UNS32		Kw		
	2810-11	MWH Used	UNS32		Mwh		
	2812-13	Peak KW	UNS32		Kw		
	2814-15	Peak KVA	UNS32		Kw		
	2816-17	Peak KVAR	UNS32		Kw		
	2818-19	Peak Amps	UNS32		Amps		
	2820-21	Peak KW Time	UNS32		1 st reg: hh,mm ; 2 nd reg: MM,DD		hh: hour, mm: minute, MM: month, DD: day.

	2822-23	Peak KVA Time	UNS32		1 ST reg: hh,mm ; 2 nd reg: MM,DD		
	2824-25	Peak KVAR Time	UNS32		1 ST reg: hh,mm ; 2 nd reg: MM,DD		
	2826-27	Peak Amps Time	UNS32		1 ST reg: hh,mm ; 2 nd reg: MM,DD		
Metering Page 3	2050	Max Temp Since Clear RTD #1	IN		Celsius (Fahrenheit)		
	2051	Max Temp Since Clear RTD #2	IN		Celsius (Fahrenheit)		
	2052	Max Temp Since Clear RTD #3	IN		Celsius (Fahrenheit)		
	2053	Max Temp Since Clear RTD #4	IN		Celsius (Fahrenheit)		
	2054	Max Temp Since Clear RTD #5	IN		Celsius (Fahrenheit)		
	2055	Max Temp Since Clear RTD #6	IN		Celsius (Fahrenheit)		
	2056	Max Temp Since Clear RTD #7	IN		Celsius (Fahrenheit)		
	2057	Max Temp Since Clear RTD #8	IN		Celsius (Fahrenheit)		
	2058	Max Temp Since Clear RTD #9	IN		Celsius (Fahrenheit)		
	2059	Max Temp Since Clear RTD #10	IN		Celsius (Fahrenheit)		
	2060	Max Temp Since Clear RTD #11	IN		Celsius (Fahrenheit)		
	2061	Max Temp Since Clear RTD #12	IN		Celsius (Fahrenheit)		
	2062	Stator Phase A1 RTD #1 (Temp)	IN		Celsius (Fahrenheit)		
	2063	Stator Phase A1 RTD #2 (Temp)	IN		Celsius (Fahrenheit)		
	2064	Stator Phase A1 RTD #3 (Temp)	IN		Celsius (Fahrenheit)		
	2065	Stator Phase A1 RTD #4 (Temp)	IN		Celsius (Fahrenheit)		
	2066	Stator Phase A1 RTD #5 (Temp)	IN		Celsius (Fahrenheit)		
	2067	Stator Phase A1 RTD #6 (Temp)	IN		Celsius (Fahrenheit)		
	2068	Stator Phase A1 RTD #7 (Temp)	IN		Celsius (Fahrenheit)		
	2069	Stator Phase A1 RTD #8 (Temp)	IN		Celsius (Fahrenheit)		
	2070	Stator Phase A1 RTD #9 (Temp)	IN		Celsius (Fahrenheit)		
	2071	Stator Phase A1 RTD #10 (Temp)	IN		Celsius (Fahrenheit)		
	2072	Stator Phase A1 RTD #11 (Temp)	IN		Celsius (Fahrenheit)		
	2073	Stator Phase A1 RTD #12 (Temp)	IN		Celsius (Fahrenheit)		
	2074	Measured Run Cool Time	UI		Celsius (Fahrenheit)		
2075	Measured Stop Cool Time	UI		Celsius (Fahrenheit)			
2076	Hottest Stator RTD#	UI		-			
2077	Hottest Stator RTD Temperature	IN		Celsius (Fahrenheit)			

	2078	Hottest Non-Stator RTD#	UI		-		
	2079	Hottest Non-Stator RTD Temp	IN		Celsius (Fahrenheit)		
Metering Page 4	2100	Model # + Firmware Rev #	UI		-		If Model # + Firmware Rev # is 6.22, it shows 622 here.
	2101	O/L Time Left to Trip	UI		Second		
	2102	Therm Inh Time Left	UI		Minute		
	2103-2104	Coast Down Timer Time Left	UNS32		Millisecond		1 st reg: LSW; 2 nd reg: MSW.
	2105-2106	Time Between Starts Time	UNS32		Millisecond		1 st reg: LSW; 2 nd reg: MSW.
	2107-2108	Starts Per Hour Time #0	UNS32		Minute		60min – Time since 1 st start.
	2109-2110	Starts Per Hour Time #1	UNS32		Minute		60min – Time since 2 nd start.
	2111-2112	Starts Per Hour Time #2	UNS32		Minute		60min – Time since 3 rd start.
	2113-2114	Starts Per Hour Time #3	UNS32		Minute		60min – Time since 4 th start.
	2115-2116	Starts Per Hour Time #4	UNS32		Minute		60min – Time since 5 th start.
	2117-2118	Starts Per Hour Time #5	UNS32		Minute		60min – Time since 6 th start.
	2119	Relay Status (Power on, Relay status)	UI		-		Bit0 of high byte: 0=Pwr off; 1=Pwr On; Bit0-7 of low byte: relay1-8. 0=relay off; 1=relay on.
	2120	Present Lcd Line1 (Char2, Char1)	UI			'O', 'M',	e.g.: MOTOR STOPPED
	2121	Present Lcd Line1 (Char4, Char3)	UI			'O', 'T',	
	2122	Present Lcd Line1 (Char6, Char5)	UI			' ', 'R',	
	2123	Present Lcd Line1 (Char8, Char7)	UI			'T', 'S',	
	2124	Present Lcd Line1 (Char10, Char9)	UI			'P', 'O',	
	2125	Present Lcd Line1 (Char12, Char11)	UI			'E', 'P',	
	2126	Present Lcd Line1 (Char14, Char13)	UI			' ', 'D',	
	2127	Present Lcd Line1 (Char16, Char15)	UI			' ', ' ',	
	2128	Present Lcd Line1 (Char18, Char17)	UI			' ', ' ',	
	2129	Present Lcd Line1 (Char20, Char19)	UI			' ', ' ',	
	2130	Present Lcd Line2 (Char2, Char1)	UI			'E', 'R',	e.g.: READY TO START
2131	Present Lcd Line2 (Char4, Char3)	UI			'D', 'A',		
2132	Present Lcd Line2 (Char6, Char5)	UI			' ', 'Y',		
2133	Present Lcd Line2 (Char8, Char7)	UI			'O', 'T',		
2134	Present Lcd Line2 (Char10, Char9)	UI			'S', ' ',		
2135	Present Lcd Line2 (Char12, Char11)	UI			'A', 'T',		
2136	Present Lcd Line2 (Char14, Char13)	UI			'T', 'R',		
2137	Present Lcd Line2 (Char16, Char15)	UI			' ', ' ',		
2138	Present Lcd Line2 (Char18, Char17)	UI			' ', ' ',		
2139	Present Lcd Line2 (Char20, Char19)	UI			' ', ' ',		

	2140	Service Code	UI				High byte: Language code; Low byte: Service code.
Metering Page 5	2900	Event Count	UI - 1-64. Numbers of events in Event Recorder – ring buffer. It also can be used for pointer while the numbers of events are less than 64, i.e. ring buffer has not been full yet.				
	2901	Event Start	UI- 0-63. A rolling pointer points to the oldest event - the starting event, while numbers of events are over 64 in ring buffer. It will not count until ring buffer is full. If (2900)<64, (2901) = 0; If (2900)=64, (2901) >=0 and Newest event entry # = (2901) – 1. It is mod 64 subtraction. For example, there are 64 events in event recorder, and the oldest event starts from event Entry #5 2980-2995. We then will have (2900)=64, Newest event entry # = (2901)-1 = 5-1= 4 and (2902)=64. And the newest event will be logged into Event Entry #4 2964-2979 because of the scrolling. Note that the newest event will override the “last” oldest event after the event recorder is full. The pointer 2901 will keep scrolling to tell us what the oldest event is - the starting event in this ring buffer.				
	2902	Event Size	UI		-		64. Fixed Number to indicate the size of Event Recorder.
	2903-2915	Reserved	-		-		
	2916	Event Entry #1: Year	UI		-		
	2917	Event Entry #1: Month & Day	UI		MM,DD		MM: month, DD: day.
	2918	Event Entry #1: Minutes & Hours	UI		mm,hh		hh: hour, mm: minute,
	2919	Event Entry #1: Milliseconds	UI		ms		
	2920	Event Entry #1: Event Code	UI				See Table 2-19
	2921	Event Entry #1: Event Parameter	UI				See Table 2-20
	2922	Event Entry #1: Current PhaseA	UI		Amps		
	2923	Event Entry #1: Current PhaseB	UI		Amps		
	2924	Event Entry #1: Current PhaseC	UI		Amps		
	2925	Event Entry #1: Current GFault	UI		Amps		
	2926	Event Entry #1: VPhaseA	UI		Volts		
	2927	Event Entry #1: VPhaseB	UI		Volts		
	2928	Event Entry #1: VPhaseC	UI		Volts		
	2929	Event Entry #1: PwrFactor	UI		-		
	2930	Event Entry #1: Reserved	-		-		
	2931	Event Entry #1: Reserved	-		-		
	2932-2947	Event Entry #2	-		-		Note: 1. Structure of #2- #64 are same as the #1. 2. Each event entry takes total sixteen registers.
	2948-2963	Event Entry #3	-		-		
	2964-2979	Event Entry #4	-		-		
2980-2995	Event Entry #5	-		-			

	2996-3011	Event Entry #6	-	-		
	3012-3027	Event Entry #7	-	-		
	3028-3043	Event Entry #8	-	-		
	3044-3059	Event Entry #9	-	-		
	3060-3075	Event Entry #10	-	-		
	3076-3091	Event Entry #11	-	-		
	---	---	-	-		
	3860-3875	Event Entry #60	-	-		
	3876-3891	Event Entry #61	-	-		
	3892-3907	Event Entry #62	-	-		
	3908-3923	Event Entry #63	-	-		
	3924-3939	Event Entry #64	-	-		
Metering Page 6	2150	Last Trip Cause	IN	-		See Table 2-20
	2151	Last Trip Value	UI	-		N/A
	2152	Last Trip Iphase A	IN	Amps		
	2153	Last Trip Iphase B	IN	Amps		
	2154	Last Trip Iphase C	IN	Amps		
	2155	Last Trip GF	IN	Amps		
	2156	Last Trip Vphase A	IN	Volts		
	2157	Last Trip Vphase B	IN	Volts		
	2158	Last Trip Vphase C	IN	Volts		
	2159	Last Trip PF	IN	-		
	2160	Last Trip IB	UI	%		
	2161	Last Trip Line Frequency (Hz)	UI	Hz		
	2162	Last Trip KW	UI	Kw		
	2163	Last Trip Hot Stator RTD #	UI	-		
	2164	Last Trip Hot Stator RTD Temperature	IN	Celsius		
	2165	Last Trip Hot Non-Stator RTD #	UI	-		
	2166	Last Trip Hot Non-Stator RTD Temperature	IN	Celsius		
	2167	Last Trip Phase Order	UI	-		See Reg Addr 1094
Metering Page 7	2200-2201	MWH Total	UNS32	Mwh		
	2202	Running Hours Total	UI	Hours		
	2203	Total Trips	UI	-		
	2204	S/C Trips	UI	-		
	2205	Start O/L Trips	UI	-		
	2206	Run O/L Trips	UI	-		
	2207	Frequency Trips	UI	-		
	2208	I/B Trips	UI	-		
	2209	Overcurrent Trips	UI	-		
	2210	Stator Trips	UI	-		
	2211	NonStator Trips	UI	-		
	2212	G/F HISET Trips	UI	-		
	2213	G/F LOSET Trips	UI	-		
	2214	Acceleration Time Trips	UI	-		
	2215	Start Curve Trips	UI	-		

2216	I*I*T Start Curve Trips	UI	-		
2217	Learned Start Curve Trips	UI	-		
2218	Shunt Trips	UI	-		
2219	Phase Loss Trips	UI	-		
2220	Tach Accel Trips	UI	-		
2221	U/V Trips	UI	-		
2222	O/V Trips	UI	-		
2223	Power Factor Accel Trips	UI	-		
2224	Voltage Phase Rev Trips	UI	-		
2225	External Input #1 Trips	UI	-		
2226	External Input #2 Trips	UI	-		
2227	External Input #3 Trips	UI	-		
2228	External Input #4 Trips	UI	-		
2229	Misc Trips	UI	-		
2230	Low Control Voltage Trips	UI			
8888	Device Category Number	UI			
8889	Reserved				

Table A-19 lists Event Code shown in Metering Page 5

Event Code	Shown in Event Recorder	Remark
6	See Event Parameter for individual event	Alarm
7	See Event Parameter for individual event	Trip
8	See Event Parameter for individual event	Trip and alarm clear
27	See Event Parameter for individual event	System Diagnostic
0xffff	DS1 POWER ON	Power on

Table A-20 lists Event Parameter shown in Metering Page 5 and Last Trip Cause in Metering Page 6

Event Parameter	Shown in Event Recorder	Remark
For Event Code 6 and 7, and Last Trip Cause:		
0	OVERLOAD WARNING	
1	IMBALANCE ALARM	
2	GROUND FAULT ALARM	
3	UNDERCURRENT ALARM	
4	OVERCURRENT ALARM	
5	THERMAL REG ALARM	
6	SELT TEST ALARM	
7	OVER VOLTAGE ALARM	
8	UNDER VOLTAGE ALARM	
9	kW DEMAND ALARM	
10	KVA DEMAND ALARM	
11	KVAR DEMAND ALARM	
12	CURRENT DEMAND ALARM	
13	PWR FACTOR LD ALARM	
14	PWR FACTOR LAG ALARM	
15	STATOR RTD ALARM	
16	RTD ALARM	
17	RTD FAILURE ALARM	
18	SPARE INPUT 1 ALARM	
19	SPARE INPUT 2 ALARM	
20	SPARE INPUT 3 ALARM	
21	SPARE INPUT 4 ALARM	
22	OVERLOAD TRIP	
23	IMBALANCE TRIP	
24	SHORT CIRCUIT TRIP	
25	STATOR TRIP	
26	RTD TRIP	
27	OVERCURRENT TRIP	
28	GROUND FAULT LO TRIP	
29	GROUND FAULT HI TRIP	
30	PHASE LOSS TRIP	
31	PHASE ORDER TRIP	
32	ACCELERATION TRIP	
33	TACH TRIP @ xxxx RPM	
34	BASIC START CRV TRIP	
35	START CRV UNDER TRIP	
36	START CRV OVER TRIP	
37	OVER VOLTAGE TRIP	
38	UNDER VOLTAGE TRIP	
39	PWR FACTOR LEAD TRIP	
40	PWR FACTOR LAG TRIP	
41	OVERFREQUENCY TRIP	
42	UNDERFREQUENCY TRIP	

43	LOW CONTROL VOLTAGE	
44	THERMAL CAP INHIB	
45	COASTDOWN TMR INHIB	
46	TIME BETWEEN INHIB	
47	STARTS PER HR INHIB	
48	BYPASS DISCREPANCY	
49	CURRENT RISE	
50	CURRENT FALL OFF	
51	INHIBITS CLEAR	
52	MOTOR RUNNING	
53	DELAYED RUN	
54	AT SPEED	
55	TIMED OUTPUT	
56	FIRING OFF	
57	SHUNT TRIP	
For Event Code 8:		
44	THERM CAP INHIB CLR	
45	COASTDOWN INHIB CLR	
46	TIME BETW INHIB CLR	
47	STARTS PER HR CLEAR	
52	BYPASS DISC. CLEAR	
53	DELAYED RUN CLEAR	
54	AT SPEED CLEAR	
55	TIMED OUTPUT CLEAR	
56	FIRING OFF CLEAR	
57	SHUNT TRIP CLEAR	
For Event Code 27:		
1	FIRMWARE UPGRADED	
2	FACTORY RESET	
3	THERMAL CAP RESET	
4	FLASH READ ERROR	
5	FLASH WRITE ERROR	
6	MEM ERROR. BATTERY?	
7	SOFTWARE RESET	
8	WATCHDOG RESET	
9	WARM REBOOT	
10	RTD INIT ERROR	
11	KEYPAD ENTRY TIMEOUT	

California Customers:

California Proposition 65 Warning

WARNING: this product and associated accessories may contain chemicals known to the State of California to cause cancer, birth defects, or other reproductive harm. For more information visit <https://p65warnings.ca.gov>



MOTORTRONICS™

Solid State AC Motor Control

MVC₄ Series

Medium Voltage Soft Starter

Phasetronics, Inc. dba Motortronics
1600 Sunshine Drive
Clearwater, Florida 33765
USA

Tel: + 727.573-1819 or 888-767-7792
Fax: + 727-573-1803 or 800-548-4104

www.motortronics.com