



Current Transformer

Model 786MR
rev 03182021

CERTIFICATIONS:



Model	786MR
Window Size	6.50
Width	9.88
Height	9.88
Depth	6.75

APPLICATION:

Relaying and metering

FREQUENCY:

50-400 Hz.

INSULATION LEVEL:

600 Volts. 10 kV BIL. Full wave

CONTINUOUS THERMAL CURRENT RATING FACTOR:

2.0 at 30°C amb., 1.5 at 55°C amb

WINDOW DIAMETER:

6.5"

APPROXIMATE WEIGHT:

58lbs.

CONNECTIONS:

-Secondary terminals are brass studs No. 10-32 with one flat washer, lockwasher, and regular nut

MODEL 786MR
Window Diameter 6.5"
Approximate weight: 58 lbs.

Catalog Number	Relay Class	ANSI Metering Class at 60Hz	Continuous Thermal	
			@ 30°C	@ 50°C
786-601MR	C200	0.6 B0.9	2.0	1.5
786-122MR	C400	0.3 B1.8	2.0	1.5
786-202MR	C400	0.3 B1.8	2.0	1.5
786-302MR	C400	0.3 B1.8	1.33	1.0
786-402MR	C400	0.3 B1.8	1.33	1.0

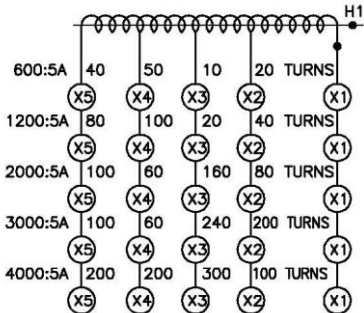
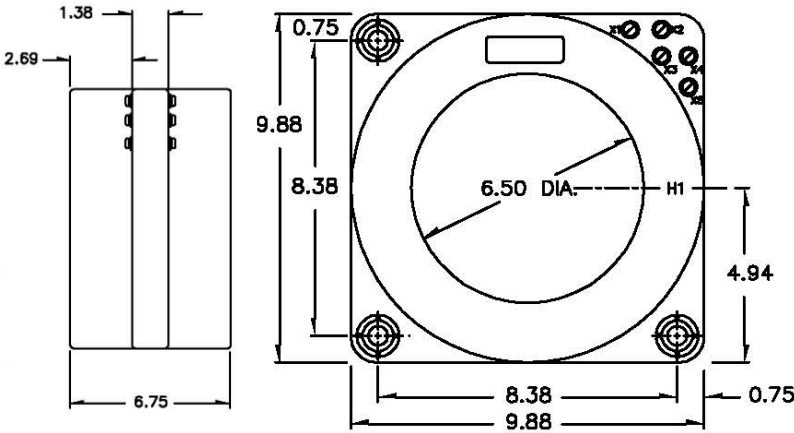

EXCITATION CURVE

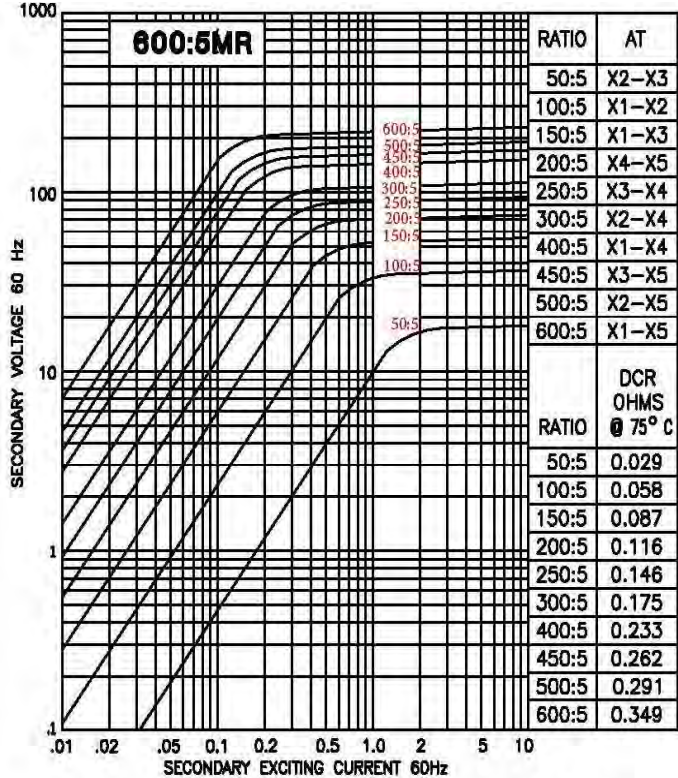

MODEL 786 - 601MR - rating C200

Products are manufactured in a plant whose quality management system has been certified to be in compliance with ISO 9001:2015 by NQA



EXCITATION CURVE

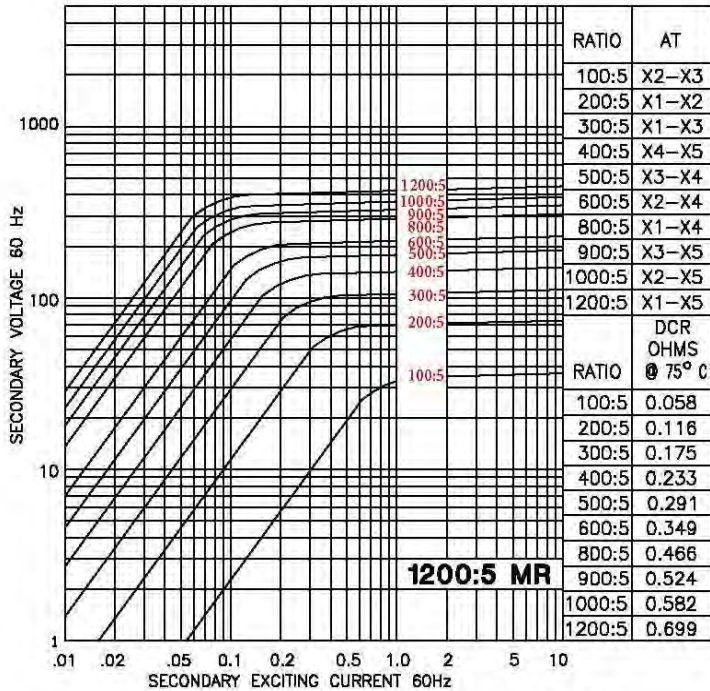

MODEL 786 - 122MR - rating C400

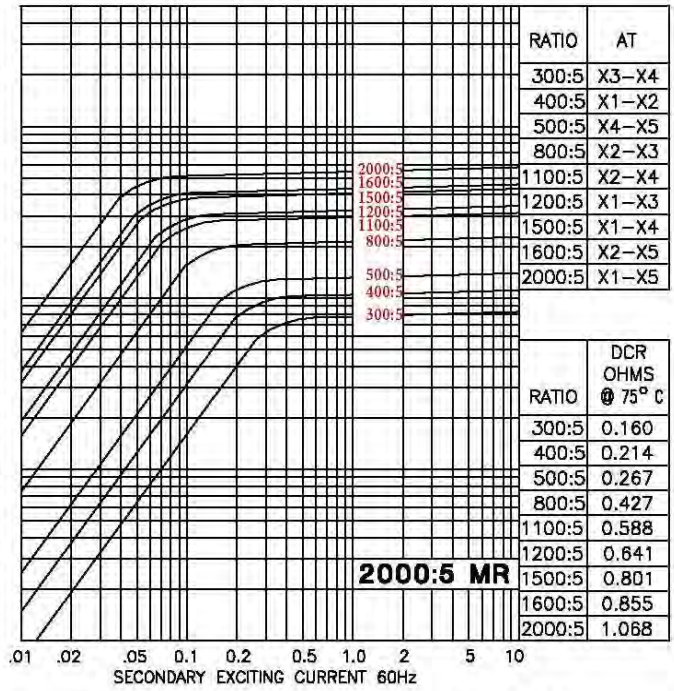

MODEL 786 - 202MR - rating C400

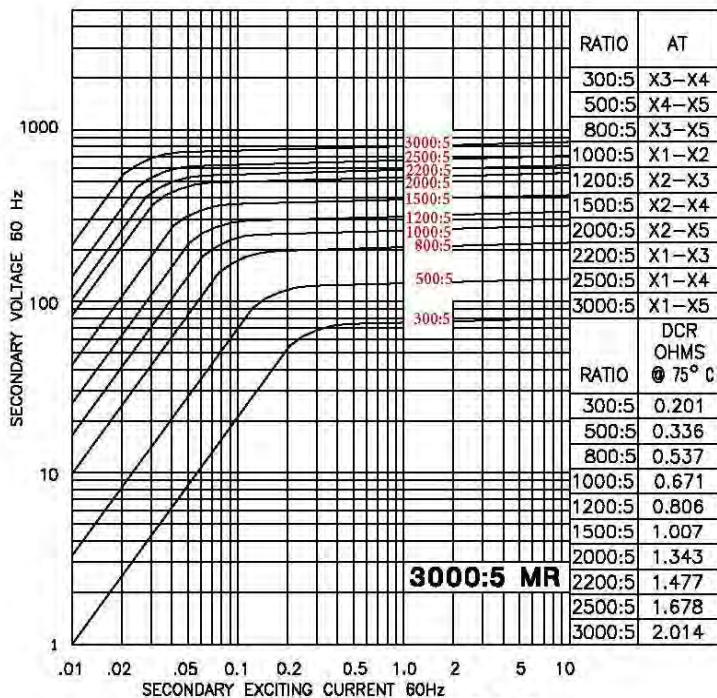

MODEL 786 - 302MR - C400

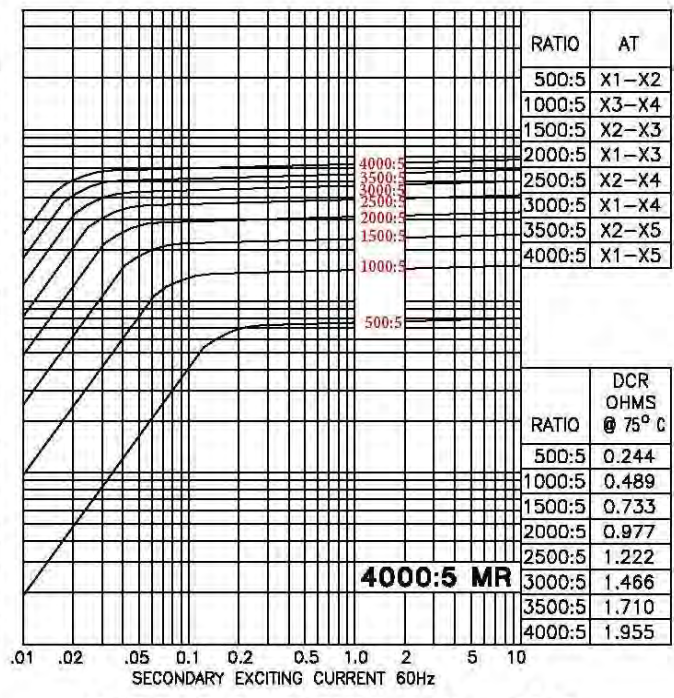

MODEL 786 - 402MR - rating C400