



# Current Transformer

**Model 785**  
rev 11052025

## CERTIFICATIONS:



**APPLICATION:**

Relaying and Metering

**FREQUENCY:**

50-400 Hz.

**INSULATION LEVEL:**

600 Volts. 10 kV BIL. full wave

**CONTINUOUS THERMAL CURRENT RATING FACTOR:**

50:5 thru 1200:5 2.0 at 30°C amb., 1.5 at 55°C amb.  
1500:5 thru 2500:5 1.5 at 30°C amb., 1.33 at 55°C amb.  
3000:5 thru 4000:5 1.33 at 30°C amb., 1.0 at 55°C amb.

**WINDOW DIAMETER:**

6.5"

**APPROXIMATE WEIGHT:**

58 lbs.

**CONNECTIONS:**

-Secondary terminals are No. 10-32 brass screws with one flat washer, lockwasher, and regular nut.

Model	785
Window Size	6.50
Width	9.88
Height	9.88
Depth	6.75

**MODEL 785**  
Window Diameter 6.5"  
Approximate weight: 58 lbs.

CATALOG NUMBER	CURRENT RATIO	RELAY CLASS	ANSI METERING CLASS AT 60 HZ				
			B0.1	B0.2	B0.5	B0.9	B1.8
785-500	50:5	C10	2.4	4.8	-	-	-
785-750	75:5	C20	1.2	1.2	4.8	-	-
785-101	100:5	C20	0.6	1.2	2.4	-	-
785-151	150:5	C50	0.6	0.6	1.2	2.4	-
785-201	200:5	C50	0.3	0.3	0.6	1.2	2.4
785-251	250:5	C50	0.3	0.3	0.6	1.2	2.4
785-301	300:5	C100	0.3	0.3	0.3	0.6	1.2
785-401	400:5	C100	0.3	0.3	0.3	0.6	1.2
785-501	500:5	C100	0.3	0.3	0.3	0.3	0.6
785-601	600:5	C200	0.3	0.3	0.3	0.3	0.6
785-751	750:5	C200	0.3	0.3	0.3	0.3	0.3
785-801	800:5	C200	0.3	0.3	0.3	0.3	0.3
785-102	1000:5	C200	0.3	0.3	0.3	0.3	0.3
785-122	1200:5	C400	0.3	0.3	0.3	0.3	0.3
785-152	1500:5	C400	0.3	0.3	0.3	0.3	0.3
785-162	1600:5	C400	0.3	0.3	0.3	0.3	0.3
785-202	2000:5	C400	0.3	0.3	0.3	0.3	0.3
785-252	2500:5	C400	0.3	0.3	0.3	0.3	0.3
785-302	3000:5	C400	0.3	0.3	0.3	0.3	0.3
785-402	4000:5	C400	0.3	0.3	0.3	0.3	0.3

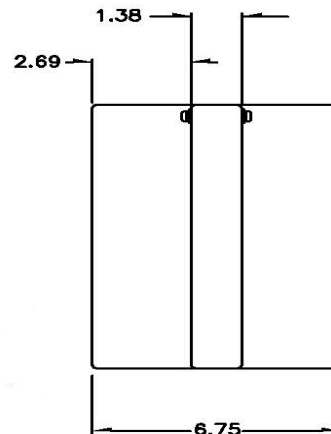
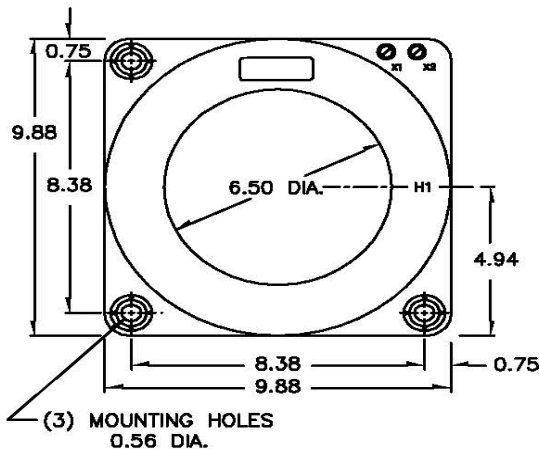

Products are manufactured in a plant whose quality management system has been certified to be in compliance with ISO 9001:2015 by NQA